

Power Operational Amplifier

FEATURES

- HIGH VOLTAGE - 300 VOLTS
- HIGH OUTPUT CURRENT – 1.5 AMPS
- 70 WATT DISSIPATION CAPABILITY
- 175 MHz GAIN BANDWIDTH
- 250 V/ μ -SECOND SLEW RATE

APPLICATIONS

- PZT DRIVE
- MAGNETIC DEFLECTION
- PROGRAMMABLE POWER SUPPLIES
- 70V LINE AUDIO to 70W

DESCRIPTION

The PA96 is a state of the art high voltage, high current operational amplifier designed to drive resistive, capacitive and inductive loads. For optimum linearity, the output stage is biased for class A/B operation. External compensation provides user flexibility in maximizing bandwidth at any gain setting. The safe operating area (SOA) can be observed for all operating conditions by selection of user programmable current limit. For continuous operation under load, a heatsink of proper rating is required.

The hybrid integrated circuit utilizes thick film (cermet) resistors, ceramic capacitors and semiconductor chips to maximize reliability, minimize size and give top performance. Ultrasonically bonded aluminum wires provide reliable interconnections at all operating temperatures. The 8-pin TO-3 package is hermetically sealed and electrically isolated. The use of compressible isolation washers voids the warranty.

EQUIVALENT CIRCUIT DIAGRAM

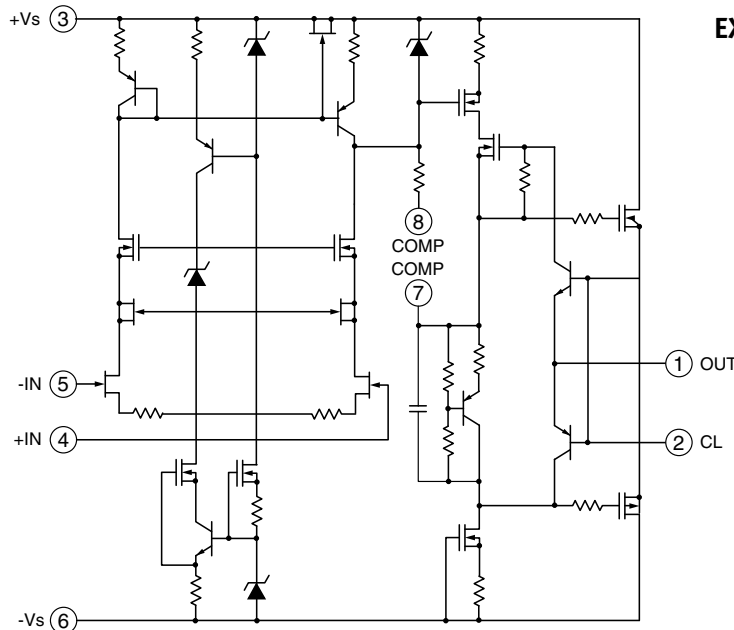

8-PIN TO-3
PACKAGE STYLE CE

TYPICAL APPLICATION

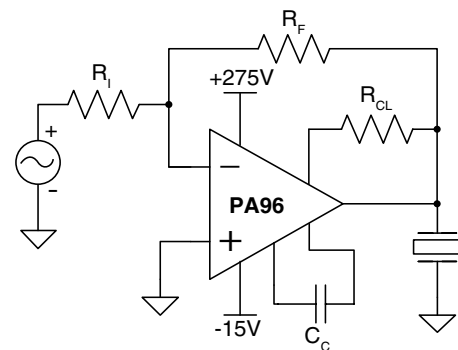

PZT POSITION CONTROL

The MOSFET output stage of the PA96 provides superior SOA performance compared to bipolar output stages where secondary breakdown is a concern. The extended SOA is ideal in applications where the load is highly reactive and may impose simultaneously both high voltage and high current across the output stage transistors. In the figure above a piezo-electric transducer is driven to high currents and high voltages by the PA96.

EXTERNAL CONNECTIONS

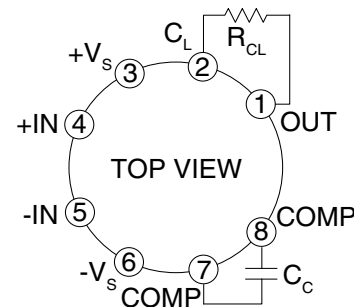

ABSOLUTE MAXIMUM RATINGS

SUPPLY VOLTAGE, +V _s to -V _s	300V
OUTPUT CURRENT, continuous	1.5A,
POWER DISSIPATION, internal, DC	70W
INPUT VOLTAGE, common mode	+V _s to -V _s
INPUT VOLTAGE, differential	±15V
TEMPERATURE, pin solder, 10s	300°C
TEMPERATURE, junction ¹	150°C
TEMPERATURE RANGE, storage	-65 to 150°C
OPERATING TEMPERATURE, case	-55 to 125°C

SPECIFICATIONS

PARAMETER	TEST CONDITIONS ²	MIN	TYP	MAX	UNITS
INPUT					
OFFSET VOLTAGE			1	5	mV
OFFSET VOLTAGE vs. temperature	Full temperature range		20	50	μV/°C
OFFSET VOLTAGE vs. supply				20	μV/V
BIAS CURRENT, initial				200	pA
BIAS CURRENT vs. supply				0.1	pA/V
OFFSET CURRENT, initial				50	pA
INPUT RESISTANCE, DC			100		GΩ
INPUT CAPACITANCE			4		pF
COMMON MODE VOLTAGE RANGE ³		+V _s - 13			V
COMMON MODE VOLTAGE RANGE ³		-V _s + 13			V
COMMON MODE REJECTION, DC		92			dB
NOISE	100KHz bandwidth, 1kΩ R _s		6		μV RMS
GAIN					
OPEN LOOP @ 15Hz	R _f = 1kΩ, C _c = 100pF	96	114		dB
GAIN BANDWIDTH PRODUCT @ 1MHz	V _S = 150V, -V _S = 150V, A = -100, R _F = 100K	100	175		MHz
PHASE MARGIN	Full temperature range, using recommended C _c for gain.	60			°
PBW	250V p-p output, 100Ω, +150V Supplies, C _c = 0pf		100		KHz
OUTPUT					
VOLTAGE SWING ³	I _o = 1.5A	+V _s - 12	+V _s - 5.6		V
VOLTAGE SWING ³	I _o = -1.5A	-V _s + 12	-V _s + 10		V
VOLTAGE SWING ³	I _o = 0.1A	+V _s - 8			V
VOLTAGE SWING ³	I _o = -0.1A	-V _s + 8			V
CURRENT, continuous, DC		1.5			A
SLEW RATE	A _v = -100, ±150V Supplies, 250Ω load negative slope, Positiveslope much faster	200	250		V/μS
SETTLING TIME, to 0.1%	A _v = -100, 1V Step, C _c = 0pF		2		μS
RESISTANCE, open loop	DC, 1A Load		7	10	Ω
THERMAL					
RESISTANCE, AC Junction to Case ⁴	Full temperature range. f > 60Hz		1.2	1.3	°C/W
RESISTANCE, DC Junction to Case	Full temperature range. f < 60Hz		1.6	1.8	°C/W
RESISTANCE, Junction to Ambient			30		°C/W
TEMPERATURE RANGE, case	Meets full range specifications	-25		85	°C
POWER SUPPLY					
VOLTAGE		±15	±100	±150	V
CURRENT, Quiescent total		25	30	35	mA
CURRENT, Quiescent output stage only			10		mA

- NOTES: 1. Long term operation at the maximum junction temperature will result in reduced product life. Derate power dissipation to achieve high MTTF.
 2. The power supply voltage specified under typical (TYP) applies unless noted as a test condition.
 3. +V_s and -V_s denote the positive and negative supply rail respectively. Total V_s is measured from +V_s to -V_s.
 4. Rating applies if the output current alternates between both output transistors at a rate faster than 60Hz.

CAUTION

The internal substrate contains beryllia (BeO). Do not break the seal. If accidentally broken, do not crush, machine, or subject to temperatures in excess of 850°C to avoid generating toxic fumes.

OPEN LOOP FREQUENCY RESPONSE

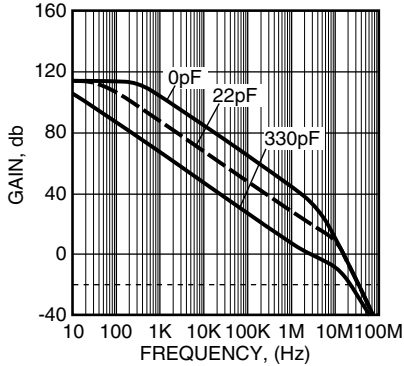

OPEN LOOP PHASE RESPONSE

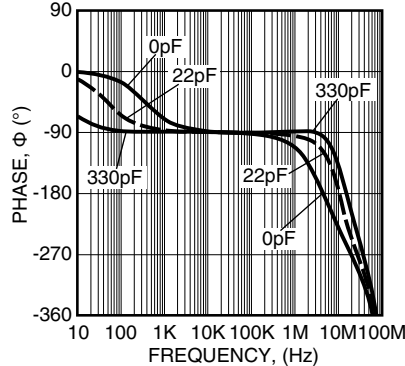

GAIN BANDWIDTH vs. +SUPPLY VOLTAGE

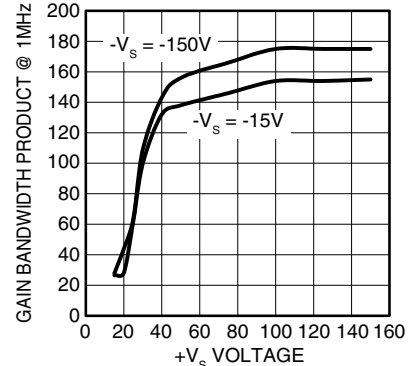

RAIL TO RAIL PULSE RESPONSE

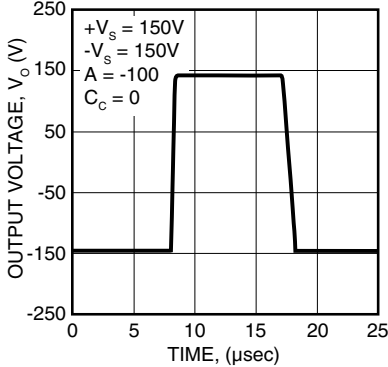

SMALL SIGNAL PULSE RESPONSE

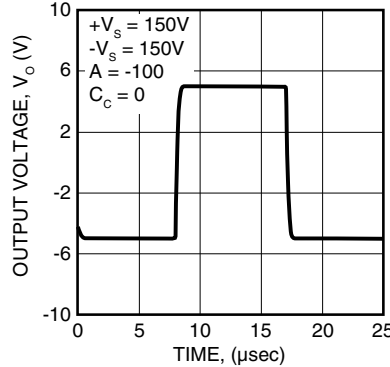

LARGE SIGNAL PULSE RESPONSE

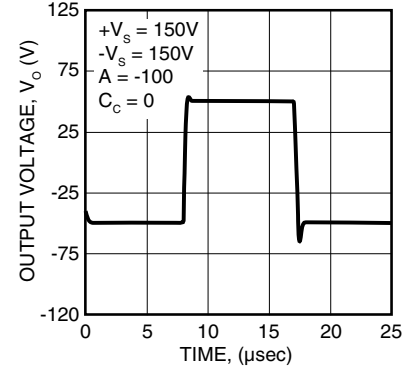

OUTPUT VOLTAGE SWING

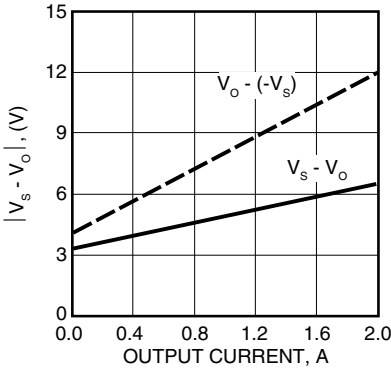

DC OFFSET vs. POWER SUPPLY

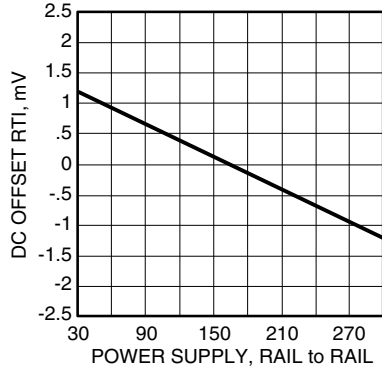

QUIESCENT CURRENT vs. TEMP.

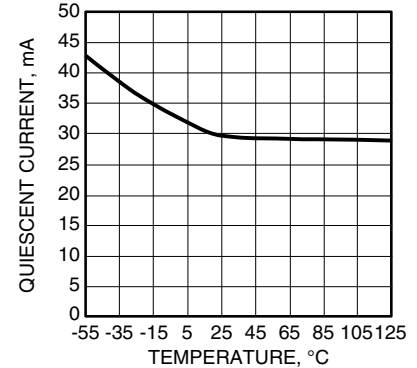

QUIESCENT CURRENT vs. POWER SUPPLY

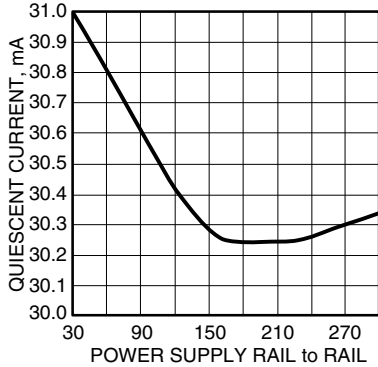

POWER DERATING

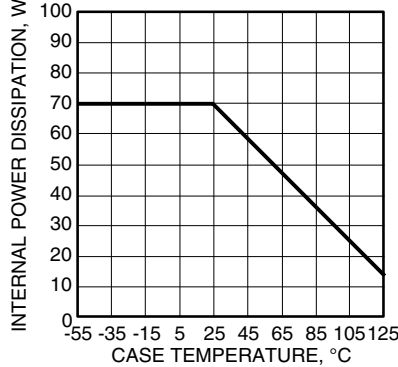

SOA

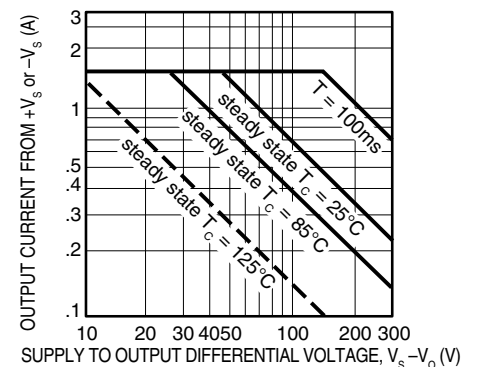

GENERAL

Please read Application Note 1 “General Operating Considerations” which covers stability, supplies, heat sinking, mounting, current limit, SOA interpretation, and specification interpretation. Visit www.Cirrus.com for design tools that help automate tasks such as calculations for stability, internal power dissipation, current limit, heat sink selection, Apex Precision Power’s Application Notes library, Technical Seminar Workbook, and Evaluation Kits.

SPECIAL PRECAUTIONS

The PA96 operates with up 300V rail to rail voltage, and delivers amperes of current. Precautions should be taken for the safety of the user and the amplifier.

Although the non-operating common mode input range is rail to rail, the differential input voltage must not exceed ± 15 V.

Therefore; if the feedback ratio is less than 10, even if caused by disconnecting a signal source, typical power turn on transients can destroy the amplifier.

Similarly in a voltage follower application a large differential transient can be generated if the slew rate of the input is greater than that of the voltage follower.

Therefore it is prudent to clamp the input with series back to back diodes as shown below.

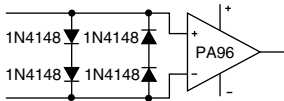

If experimentally optimizing the compensation capacitor, turn off the supplies and let them bleed to low voltage before installing each new value. Otherwise internal current pulses of up to 3 amps can be induced. Also, do you want your fingers around 300V?

Essentially the full rail to rail power supply voltage may be applied to the compensation capacitor. A 400V COG or Mica capacitor is recommended.

POWER BANDWIDTH

The power bandwidth is $1/(\pi \times \text{the negative edge slew time})$. The slew time is determined by the compensation capacitor, load, and internal device capacitance; it is independent of closed loop gain. The uncompensated power bandwidth is typically 100kHz for a 250Vp-p output signal into 100 Ω . It typically increases to above 300kHz with no load.

COMPENSATION TABLE

The following table tabulates recommended compensation capacitor values vs. gain. These values will typically result in less than 2% overshoot and a -3db small signal bandwidth of greater than 1MHz, except under operating conditions where uncompensated gain bandwidth is too low to support a 1MHz bandwidth. (See gain bandwidth vs. Plus power supply curves). Note that other factors such as capacitance in parallel with the feedback resistor may reduce circuit bandwidth from that determined from the gain bandwidth curve.

Cc	Inverting Gain	
	From	To
150pf	1	2
51pf	2	5
33pf	5	10
22pf	10	20
10pf	20	50
5pf	50	100
None	100	up

Cc	Non-Inverting Gain	
	From	To
330 pf	1	2
150pf	2	3
51pf	3	6
33pf	6	10
22pf	10	20
10pf	20	50
5pf	50	100
None	100	up

CURRENT LIMIT

For proper operation the current limit resistor, R_{cl}, must be connected as shown in the external connections diagram. The minimum value is 0.2 Ω , with a maximum practical value of 100 Ω . For optimum reliability the resistor should be set as high as possible. The value is calculated as $I_L = 0.68V/R_{cl}$. Note that the 0.68V is reduced by 2mV every $^{\circ}\text{C}$ rise in temperature.

Also note that the current limit can be set such that the SOA is exceeded on a continuous basis. As an example if the current limit was set at 1.5A and the supply was at 150V, a short to ground would produce 225 watts internal dissipation, greatly exceeding the 83 watt steady state SOA rating.

Under some conditions of load and compensation the amplifier may oscillate at a low level when current limit is active, even though the amplifier is stable otherwise. The current will be limited to the programmed value in this situation. To minimize such occurrences, use a non-reactive resistor to program current limit.



CONTACTING CIRRUS LOGIC SUPPORT

For all Apex Precision Power product questions and inquiries, call toll free 800-546-2739 in North America.

For inquiries via email, please contact apex.support@cirrus.com.

International customers can also request support by contacting their local Cirrus Logic Sales Representative.

To find the one nearest to you, go to www.cirrus.com

IMPORTANT NOTICE

Cirrus Logic, Inc. and its subsidiaries ("Cirrus") believe that the information contained in this document is accurate and reliable. However, the information is subject to change without notice and is provided "AS IS" without warranty of any kind (express or implied). Customers are advised to obtain the latest version of relevant information to verify, before placing orders, that information being relied on is current and complete. All products are sold subject to the terms and conditions of sale supplied at the time of order acknowledgment, including those pertaining to warranty, indemnification, and limitation of liability. No responsibility is assumed by Cirrus for the use of this information, including use of this information as the basis for manufacture or sale of any items, or for infringement of patents or other rights of third parties. This document is the property of Cirrus and by furnishing this information, Cirrus grants no license, express or implied under any patents, mask work rights, copyrights, trademarks, trade secrets or other intellectual property rights. Cirrus owns the copyrights associated with the information contained herein and gives consent for copies to be made of the information only for use within your organization with respect to Cirrus integrated circuits or other products of Cirrus. This consent does not extend to other copying such as copying for general distribution, advertising or promotional purposes, or for creating any work for resale.

CERTAIN APPLICATIONS USING SEMICONDUCTOR PRODUCTS MAY INVOLVE POTENTIAL RISKS OF DEATH, PERSONAL INJURY, OR SEVERE PROPERTY OR ENVIRONMENTAL DAMAGE ("CRITICAL APPLICATIONS"). CIRRUS PRODUCTS ARE NOT DESIGNED, AUTHORIZED OR WARRANTED TO BE SUITABLE FOR USE IN PRODUCTS SURGICALLY IMPLANTED INTO THE BODY, AUTOMOTIVE SAFETY OR SECURITY DEVICES, LIFE SUPPORT PRODUCTS OR OTHER CRITICAL APPLICATIONS. INCLUSION OF CIRRUS PRODUCTS IN SUCH APPLICATIONS IS UNDERSTOOD TO BE FULLY AT THE CUSTOMER'S RISK AND CIRRUS DISCLAIMS AND MAKES NO WARRANTY, EXPRESS, STATUTORY OR IMPLIED, INCLUDING THE IMPLIED WARRANTIES OF MERCHANTABILITY AND FITNESS FOR PARTICULAR PURPOSE, WITH REGARD TO ANY CIRRUS PRODUCT THAT IS USED IN SUCH A MANNER. IF THE CUSTOMER OR CUSTOMER'S CUSTOMER USES OR PERMITS THE USE OF CIRRUS PRODUCTS IN CRITICAL APPLICATIONS, CUSTOMER AGREES, BY SUCH USE, TO FULLY INDEMNIFY CIRRUS, ITS OFFICERS, DIRECTORS, EMPLOYEES, DISTRIBUTORS AND OTHER AGENTS FROM ANY AND ALL LIABILITY, INCLUDING ATTORNEYS' FEES AND COSTS, THAT MAY RESULT FROM OR ARISE IN CONNECTION WITH THESE USES.

Cirrus Logic, Cirrus, and the Cirrus Logic logo designs, Apex Precision Power, Apex and the Apex Precision Power logo designs are trademarks of Cirrus Logic, Inc. All other brand and product names in this document may be trademarks or service marks of their respective owners.