



Micro Commercial Components



Micro Commercial Components
 20736 Marilla Street Chatsworth
 CA 91311
 Phone: (818) 701-4933
 Fax: (818) 701-4939

KSD471A-O KSD471A-Y KSD471A-G

NPN Silicon Transistors

Features

- Halogen free available upon request by adding suffix "-HF"
- Lead Free Finish/RoHS Compliant ("P" Suffix designates RoHS Compliant. See ordering information)
- Collector Dissipation : $I_C = 1A$
- Collector Current : $P_C = 800mW$
- Epoxy meets UL 94 V-0 flammability rating
- Moisture Sensitivity Level 1

Maximum Ratings

Symbol	Rating	Rating	Unit
V_{CEO}	Collector-Emitter Voltage	30	V
V_{CBO}	Collector-Base Voltage	40	V
V_{EBO}	Emitter-Base Voltage	5.0	V
I_C	Collector Current	1	A
P_C	Collector power dissipation	800	mW
T_J	Junction Temperature	150	°C
T_{STG}	Storage Temperature	-55 to +150	°C

Electrical Characteristics @ 25°C Unless Otherwise Specified

Symbol	Parameter	Min	Typ	Max	Units
--------	-----------	-----	-----	-----	-------

OFF CHARACTERISTICS

$V_{(BR)CBO}$	Collector-Base Breakdown Voltage ($I_C=100\mu A, I_E=0$)	40	---	---	Vdc
$V_{(BR)CEO}$	Collector-Emitter Breakdown Voltage ($I_C=10mA, I_B=0$)	30	---	---	Vdc
$V_{(BR)EBO}$	Emitter-Base Breakdown Voltage ($I_E=100\mu A, I_C=0$)	5.0	---	---	Vdc
I_{CBO}	Collector-Base Cutoff Current ($V_{CB}=30Vdc, I_E=0$)	---	---	0.1	μA

ON CHARACTERISTICS

h_{FE}	Forward Current Transfer ratio* ($I_C=0.1A, V_{CE}=1.0Vdc$)	70	---	400	---
$V_{CE(sat)}$	Collector-Emitter Saturation Voltage ($I_C=1A, I_B=0.1A$)	---	---	0.5	Vdc
f_T	Transition Frequency ($V_{CE}=6Vdc, I_C=10mA$)	---	130	---	MHz
C_{ob}	Collector Output Capacitance ($V_{CB}=6Vdc, I_E=0, f=1.0MHz$)	---	16	---	pF

CLASSIFICATION OF h_{FE}

Rank	O	Y	G
Range	70-140	120-240	200-400

TO-92

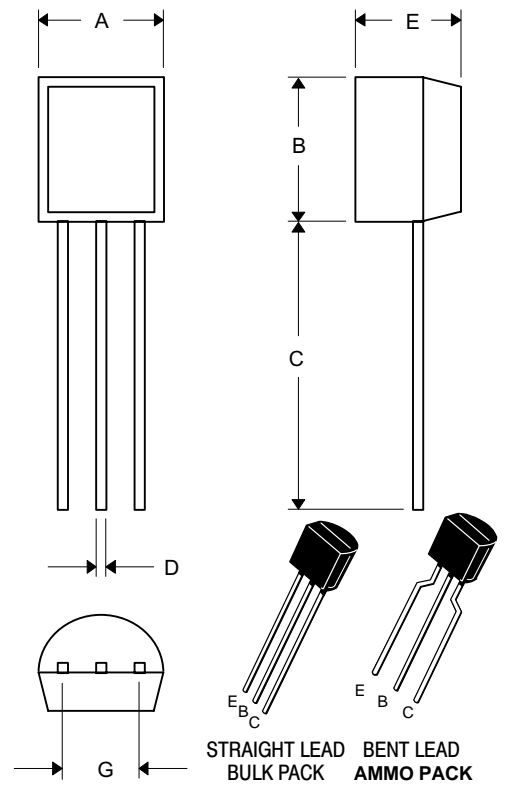

DIM	DIMENSIONS				NOTE
	INCHES		MM		
A	.175	.185	4.45	4.70	
B	.175	.185	4.45	4.70	
C	.500	---	12.70	---	
D	.016	.020	0.41	0.63	
E	.135	.145	3.43	3.68	
G	.095	.105	2.42	2.67	Straight Lead
	.173	.220	4.40	5.60	Bent Lead

* For ammo packing detailed specification, click here to visit our website of product packaging for details.

KSD471A

Typical Characteristics

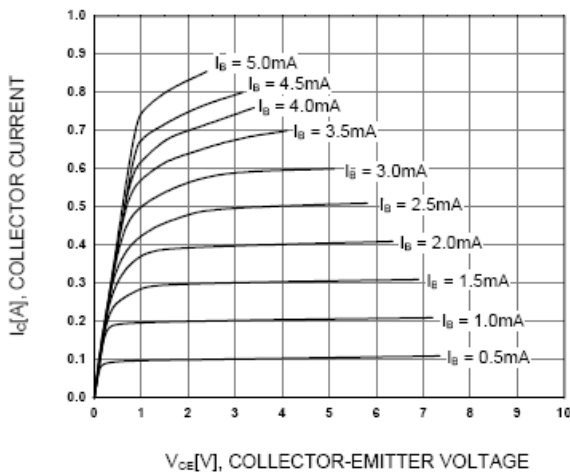

Figure 1. Static Characteristic

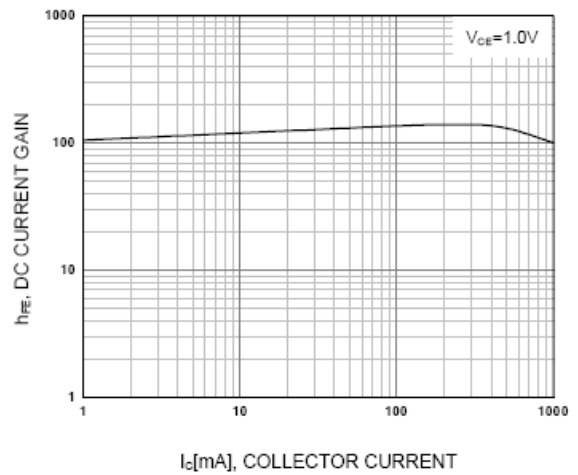

Figure 2. DC current Gain

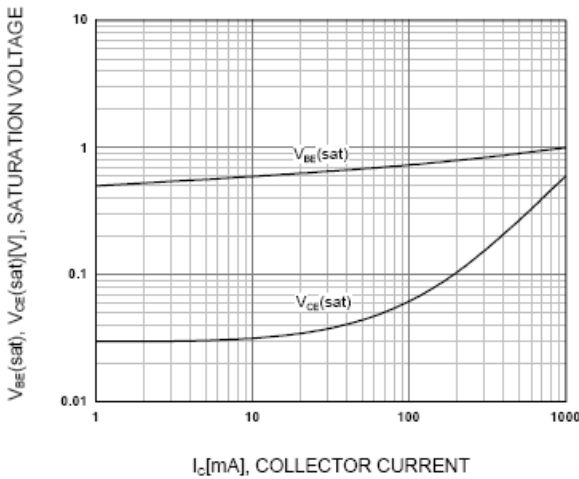

Figure 3. Base-Emitter Saturation Voltage
Collector-Emitter Saturation Voltage

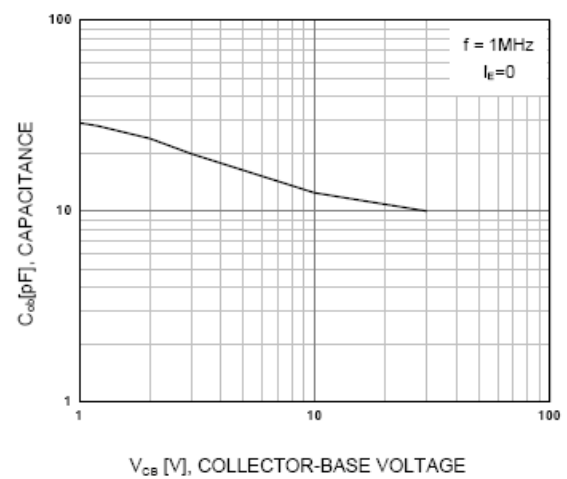

Figure 4. Collector Output Capacitance

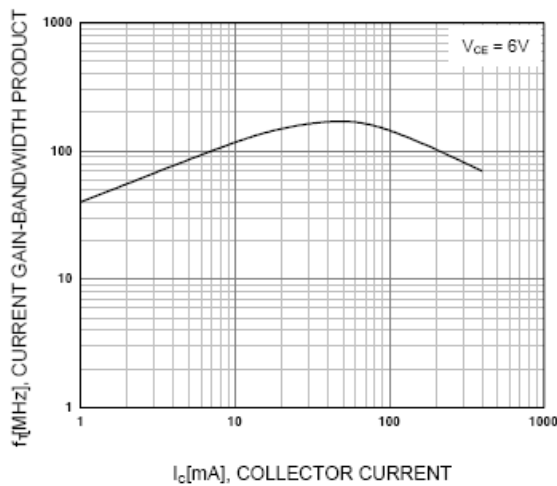

Figure 5. Current Gain Bandwidth Product

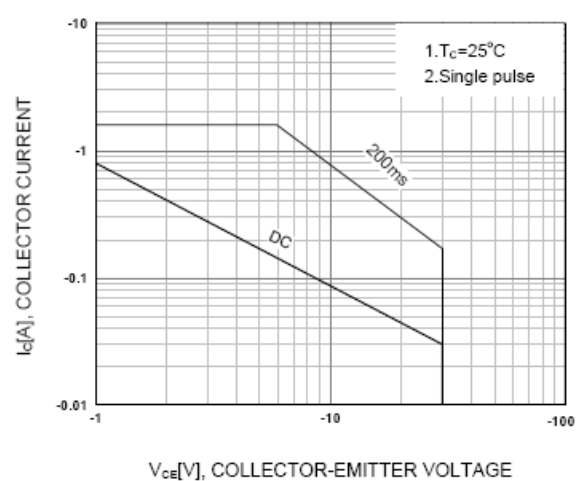

Figure 6. Safe Operating Area



Micro Commercial Components

Ordering Information :

Device	Packing
Part Number-AP	Ammo Packing: 20Kpcs/Carton
Part Number-BP	Bulk: 100Kpcs/Carton

Note : Adding "-HF" suffix for halogen free, eg. Part Number-AP-HF

*****IMPORTANT NOTICE*****

Micro Commercial Components Corp. reserves the right to make changes without further notice to any product herein to make corrections, modifications, enhancements, improvements, or other changes. **Micro Commercial Components Corp.** does not assume any liability arising out of the application or use of any product described herein; neither does it convey any license under its patent rights, nor the rights of others. The user of products in such applications shall assume all risks of such use and will agree to hold **Micro Commercial Components Corp.** and all the companies whose products are represented on our website, harmless against all damages.

*****LIFE SUPPORT*****

MCC's products are not authorized for use as critical components in life support devices or systems without the express written approval of Micro Commercial Components Corporation.

*****CUSTOMER AWARENESS*****

Counterfeiting of semiconductor parts is a growing problem in the industry. Micro Commercial Components (MCC) is taking strong measures to protect ourselves and our customers from the proliferation of counterfeit parts. MCC strongly encourages customers to purchase MCC parts either directly from MCC or from Authorized MCC Distributors who are listed by country on our web page cited below. Products customers buy either from MCC directly or from Authorized MCC Distributors are genuine parts, have full traceability, meet MCC's quality standards for handling and storage. **MCC will not provide any warranty coverage or other assistance for parts bought from Unauthorized Sources.** MCC is committed to combat this global problem and encourage our customers to do their part in stopping this practice by buying direct or from authorized distributors.

www.mccsemi.com