

SWITCHMODE™ Series NPN Silicon Power Transistor

The MJ13333 transistor is designed for high voltage, high-speed, power switching in inductive circuits where fall time is critical. It is particularly suited for line operated SWITCHMODE applications such as:

- Switching Regulators
- Inverters
- Solenoid and Relay Drivers
- Motor Controls
- Deflection Circuits
- Fast Turn Off Times
 - 200 ns Inductive Fall Time — 25°C (Typ)
 - 1.8 μs Inductive Storage Time — 25°C (Typ)
- Operating Temperature Range –65 to +200°C
- 100°C Performance Specified for:
 - Reversed Biased SOA with Inductive Loads
 - Switching Times with Inductive Loads
 - Saturation Voltages
 - Leakage Currents

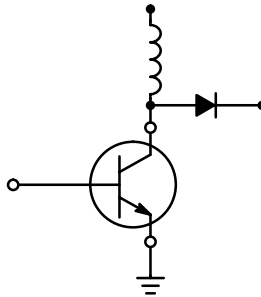

MJ13333

**20 AMPERE
NPN SILICON
POWER TRANSISTORS
400–500 VOLTS
175 WATTS**

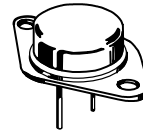

**CASE 1-07
TO-204AA
(TO-3)**

MAXIMUM RATINGS

Rating	Symbol	Value	Unit
Collector–Emitter Voltage	V_{CEO}	400	Vdc
Collector–Emitter voltage	V_{CEV}	700	Vdc
Emitter Base Voltage	V_{EB}	6.0	Vdc
Collector Current — Continuous Peak (1)	I_C I_{CM}	20 30	Adc
Base Current — Continuous Peak (1)	I_B I_{BM}	10 15	Adc
Total Power Dissipation @ $T_C = 25^\circ\text{C}$ @ $T_C = 100^\circ\text{C}$ Derate above 25°C	P_D	175 100 1.0	Watts W/°C
Operating and Storage Junction Temperature Range	T_J, T_{stg}	–65 to +200	°C

THERMAL CHARACTERISTICS

Characteristic	Symbol	Max	Unit
Thermal Resistance, Junction to Case	$R_{\theta JC}$	1.0	°C/W
Maximum Lead Temperature for Soldering Purposes 1/8" from Case for 5 Seconds	T_L	275	°C

- (1) Pulse Test: Pulse Width = 5 ms, Duty Cycle $\leq 10\%$.
Similar device types available with lower V_{CEO} ratings, see the MJ13330 (200 V) and MJ13331 (250 V).

MJ13333

ELECTRICAL CHARACTERISTICS ($T_C = 25^\circ\text{C}$ unless otherwise noted)

Characteristic	Symbol	Min	Typ	Max	Unit
----------------	--------	-----	-----	-----	------

OFF CHARACTERISTICS

Collector–Emitter Sustaining Voltage (Table 1) ($I_C = 100\text{ mA}$, $I_B = 0$)	$V_{CEO(sus)}$	400	—	—	Vdc
Collector Cutoff Current ($V_{CEV} = \text{Rated Value}$, $V_{BE(off)} = 1.5\text{ Vdc}$) ($V_{CEV} = \text{Rated Value}$, $V_{BE(off)} = 1.5\text{ Vdc}$, $T_C = 150^\circ\text{C}$)	I_{CEV}	—	—	0.25 5.0	mAdc
Collector Cutoff Current ($V_{CE} = \text{Rated } V_{CEV}$, $R_{BE} = 50\ \Omega$, $T_C = 100^\circ\text{C}$)	I_{CER}	—	—	5.0	mAdc
Emitter Cutoff Current ($V_{EB} = 6.0\text{ Vdc}$, $I_C = 0$)	I_{EBO}	—	—	1.0	mAdc

SECOND BREAKDOWN

Second Breakdown Collector Current with base forward biased	$I_{S/b}$	See Figure 12			
Clamped Inductive SOA with Base Reverse Biased	RBSOA	See Figure 13			

ON CHARACTERISTICS (1)

DC Current Gain ($I_C = 5.0\text{ Adc}$, $V_{CE} = 5.0\text{ Vdc}$)	h_{FE}	10	—	60	—
Collector–Emitter Saturation Voltage ($I_C = 10\text{ Adc}$, $I_B = 2.0\text{ Adc}$) ($I_C = 20\text{ Adc}$, $I_B = 6.7\text{ Adc}$) ($I_C = 10\text{ Adc}$, $I_B = 2.0\text{ Adc}$, $T_C = 100^\circ\text{C}$)	$V_{CE(sat)}$	—	—	1.8 5.0 2.4	Vdc
Base Emitter Saturation Voltage ($I_C = 10\text{ Adc}$, $I_B = 2.0\text{ Adc}$) ($I_C = 10\text{ Adc}$, $I_B = 2.0\text{ Adc}$, $T_C = 100^\circ\text{C}$)	$V_{BE(sat)}$	—	—	1.8 1.8	Vdc

DYNAMIC CHARACTERISTICS

Output Capacitance ($V_{CB} = 10\text{ Vdc}$, $I_E = 0$, $f_{test} = 1.0\text{ kHz}$)	C_{ob}	125	—	500	pF
----------------------------------------------------------------------------------------------	----------	-----	---	-----	----

SWITCHING CHARACTERISTICS

Resistive Load (Table 1)						
Delay Time	$(V_{CC} = 250\text{ Vdc}$, $I_C = 10\text{ A}$, $I_{B1} = 2.0\text{ A}$, $V_{BE(off)} = 5.0\text{ Vdc}$, $t_p = 10\ \mu\text{s}$, Duty Cycle $\leq 2.0\%$)	t_d	—	0.02	0.1	μs
Rise Time		t_r	—	0.3	0.7	μs
Storage Time		t_s	—	1.6	4.0	μs
Fall Time		t_f	—	0.3	0.7	μs
Inductive Load, Clamped (Table 1)						
Storage Time	$(I_C = 10\text{ A(pk)}$, $V_{clamp} = 250\text{ Vdc}$, $I_{B1} = 2.0\text{ A}$, $V_{BE(off)} = 5\text{ Vdc}$, $T_C = 100^\circ\text{C}$)	t_{sv}	—	2.5	5.0	μs
Crossover Time		t_c	—	0.8	2.0	μs
Storage Time	$(I_C = 10\text{ A(pk)}$, $V_{clamp} = 250\text{ Vdc}$, $I_{B1} = 2.0\text{ A}$, $V_{BE(off)} = 5\text{ Vdc}$, $T_C = 25^\circ\text{C}$)	t_{sv}	—	1.8	—	μs
Crossover Time		t_c	—	0.4	—	μs
Fall Time		t_{fi}	—	0.2	—	μs

(1) Pulse Test: $PW = 300\ \mu\text{s}$, Duty Cycle $\leq 2\%$.

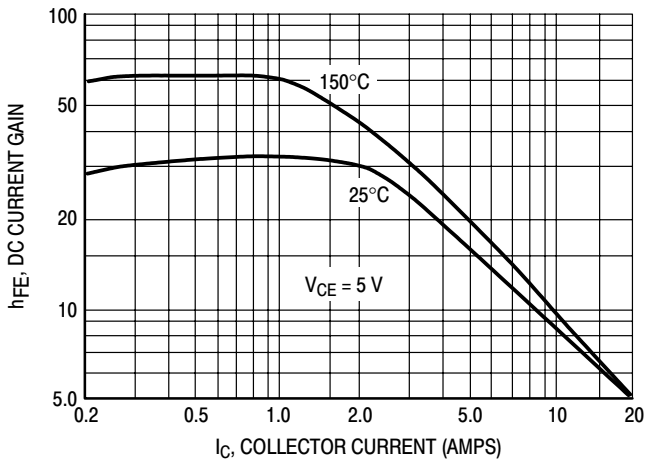

Figure 1. DC Current Gain

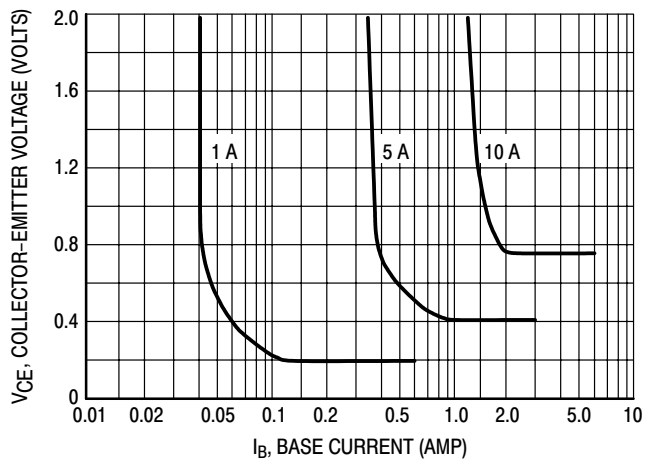

Figure 2. Collector Saturation Region

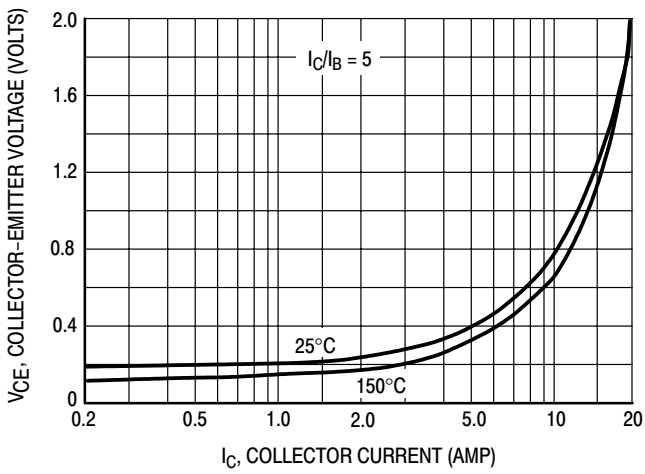

Figure 3. Collector-Emitter Saturation Region

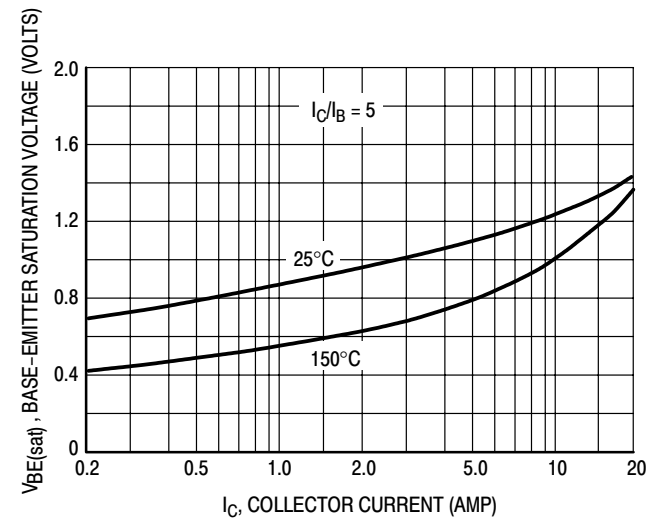

Figure 4. Base-Emitter Voltage

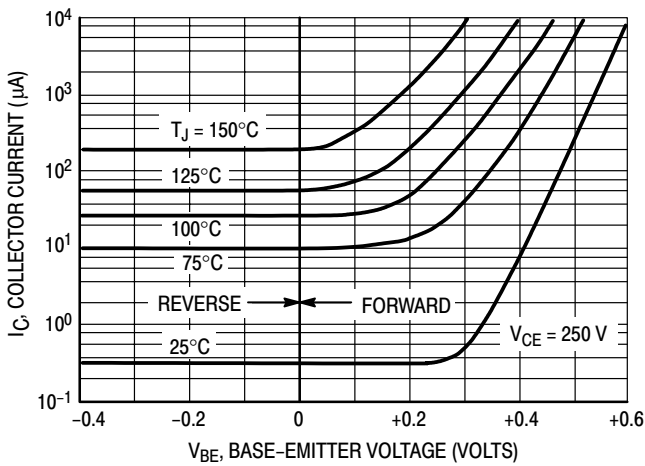

Figure 5. Collector Cutoff Region

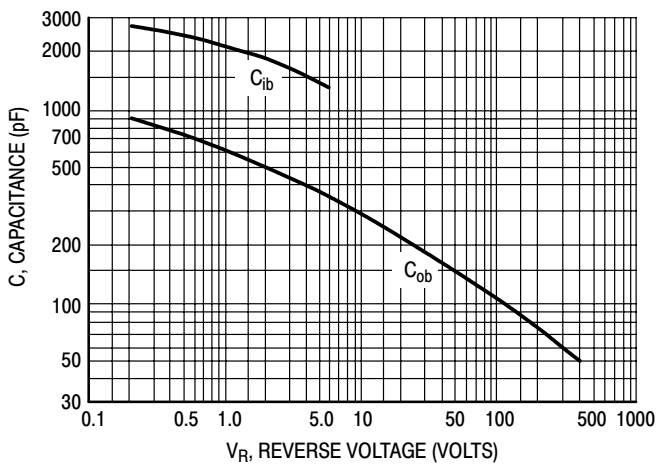

Figure 6. Capacitance

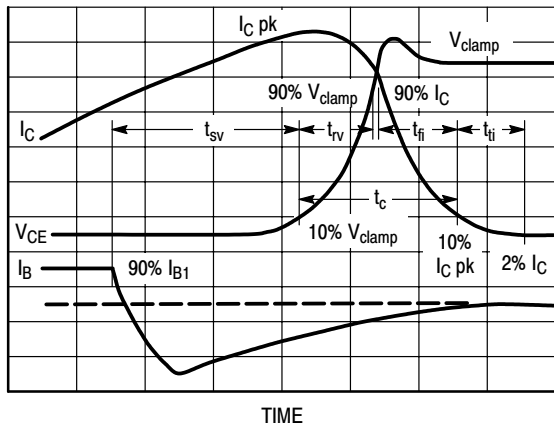

Figure 7. Inductive Switching Measurements

SWITCHING TIMES NOTE

In resistive switching circuits, rise, fall, and storage times have been defined and apply to both current and voltage waveforms since they are in phase. However, for inductive loads which are common to SWITCHMODE power supplies and hammer drivers, current and voltage waveforms are not in phase. Therefore, separate measurements must be made on each waveform to determine the total switching time. For this reason, the following new terms have been defined.

- t_{sv} = Voltage Storage Time, 90% I_{B1} to 10% V_{clamp}
- t_{rv} = Voltage Rise Time, 10 – 90% V_{clamp}
- t_{fi} = Current Fall Time, 90 – 10% I_C
- t_{ti} = Current Tail, 10 – 2% I_C
- t_c = Crossover Time, 10% V_{clamp} to 10% I_C

An enlarged portion of the inductive switching waveforms is shown in Figure 7 to aid in the visual identity of these terms.

For the designer, there is minimal switching loss during storage time and the predominant switching power losses occur during the crossover interval and can be obtained using the standard equation from AN-222:

$$P_{SWT} = 1/2 V_{CC} I_C (t_c) f$$

In general, $t_{rv} + t_{fi} \approx t_c$. However, at lower test currents this relationship may not be valid.

As is common with most switching transistors, resistive switching is specified at 25°C and has become a benchmark for designers. However, for designers of high frequency converter circuits, the user oriented specifications which make this a “SWITCHMODE” transistor are the inductive switching speeds (t_c and t_{sv}) which are guaranteed at 100°C.

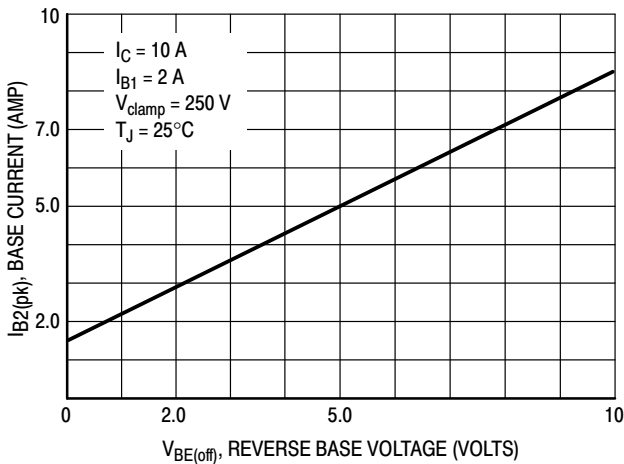

Figure 8. Reverse Base Current versus $V_{BE(off)}$ With No External Base Resistance

RESISTIVE SWITCHING PERFORMANCE

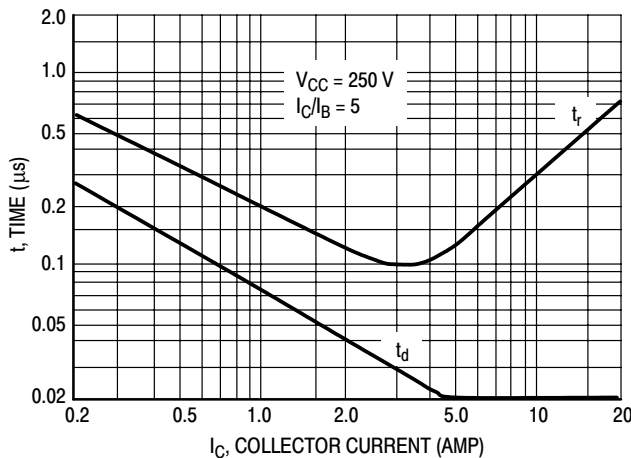

Figure 9. Turn-On Switching Times

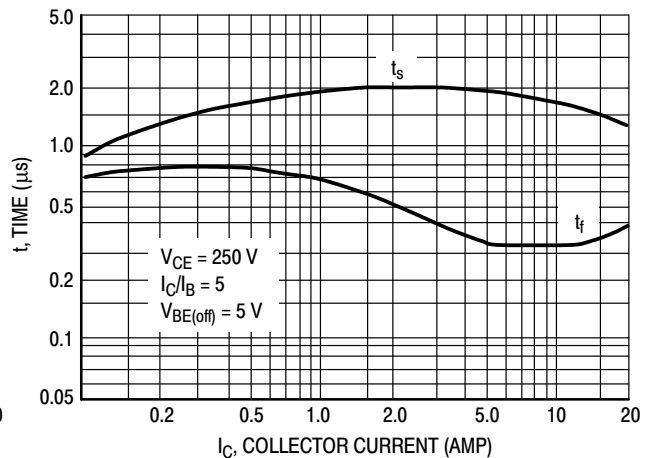
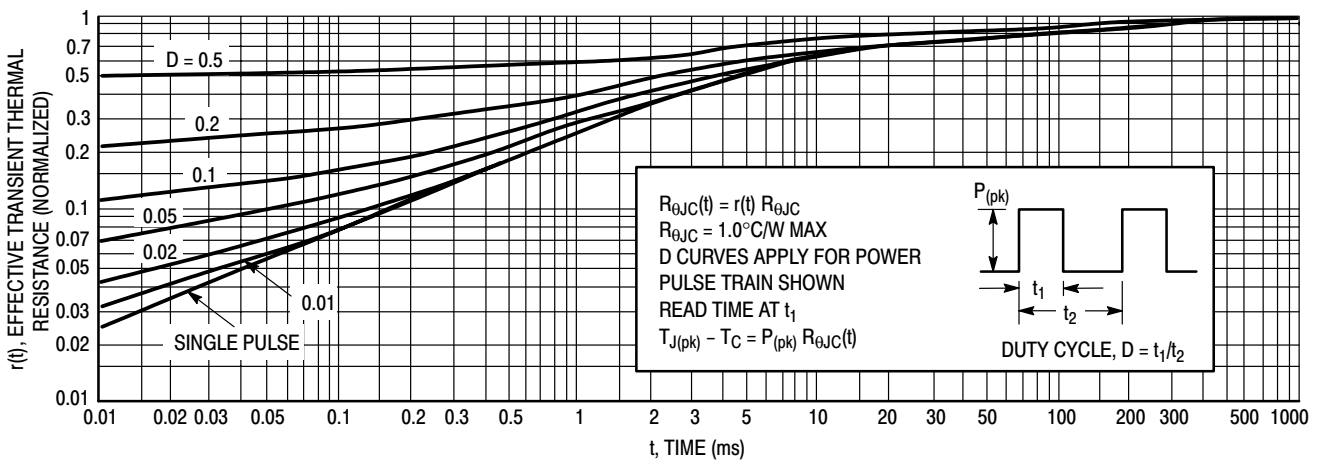

Figure 10. Turn-Off Switching Times

Table 1. Test Conditions for Dynamic Performance

	V _{CEO(sus)}	RBSOA AND INDUCTIVE SWITCHING	RESISTIVE SWITCHING
INPUT CONDITIONS	<p>PW Varied to Attain I_C = 100 mA</p>	<p>All Diodes — 1N4934 All NPN — MJE200 All PNP — MJE210</p> <p>Adjust R1 to obtain I_{B1} For switching and RBSOA, R2 = 0 For V_{CEO(sus)}, R2 = ∞</p>	<p>TURN-ON TIME</p> <p>I_{B1} adjusted to obtain the forced h_{FE} desired</p> <p>TURN-OFF TIME</p> <p>Use inductive switching driver as the input to the resistive test circuit.</p>
CIRCUIT VALUES	L _{coil} = 80 mH, V _{CC} = 10 V R _{coil} = 0.7 Ω	L _{coil} = 180 μH R _{coil} = 0.05 Ω V _{CC} = 20 V V _{clamp} = 250 V R _B adjusted to attain desired I _{B1}	V _{CC} = 250 V R _L = 50 Ω Pulse Width = 10 μs
TEST CIRCUITS	<p>INDUCTIVE TEST CIRCUIT</p> <p>SEE ABOVE FOR DETAILED CONDITIONS</p>	<p>OUTPUT WAVEFORMS</p> <p>t₁ Adjusted to Obtain I_C</p> $t_1 = \frac{L_{coil} (I_{Cpk})}{V_{CC}}$ $t_2 = \frac{L_{coil} (I_{Cpk})}{V_{Clamp}}$ <p>Test Equipment Scope — Tektronix 475 or Equivalent</p>	<p>RESISTIVE TEST CIRCUIT</p>



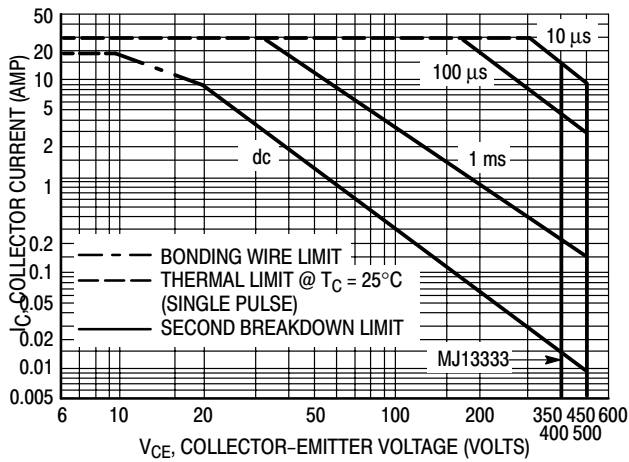

Figure 12. Forward Bias Safe Operating Area

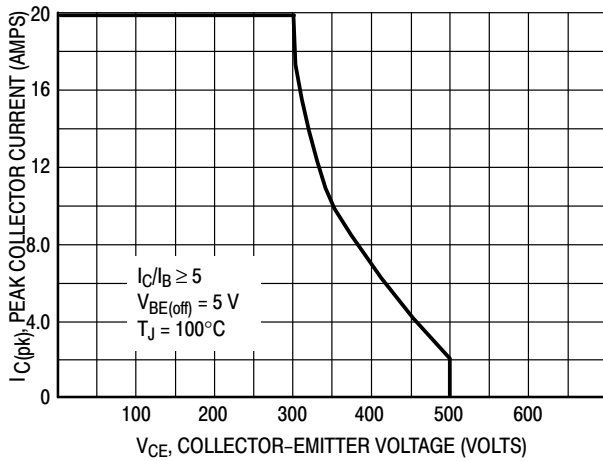

Figure 13. RBSOA, Reverse Bias Switching Safe Operating Area

SAFE OPERATING AREA INFORMATION

FORWARD BIAS

There are two limitations on the power handling ability of a transistor average junction temperature and second breakdown. Safe operating area curves indicate $I_C - V_{CE}$ limits of the transistor that must be observed for reliable operation, i.e., the transistor must not be subjected to greater dissipation than the curves indicate.

The data of Figure 12 is based on $T_C = 25^\circ\text{C}$. $T_{J(pk)}$ is variable depending on power level. Second breakdown pulse limits are valid for duty cycles to 10% but must be derated when $T_C \geq 25^\circ\text{C}$. Second breakdown limitations do not derate the same as thermal limitations. Allowable current at the voltages shown on Figure 12 may be found at any case temperature by using the appropriate curve on Figure 14.

$T_{J(pk)}$ may be calculated from the data in Figure 11. At high case temperatures, thermal limitations will reduce the power that can be handled to values less than the limitations imposed by second breakdown.

REVERSE BIAS

For inductive loads, high voltage and high current must be sustained simultaneously during turn-off, in most cases, with the base to emitter junction reverse biased. Under these conditions the collector voltage must be held to a safe level at or below a specific value of collector current. This can be accomplished by several means such as active clamping, RC snubbing, load line shaping, etc. The safe level for these devices is specified as Reverse Bias Safe Operating Area and represents the voltage-current condition allowable during reverse biased turn-off. This rating is verified under clamped conditions so that the device is never subjected to an avalanche mode. Figure 13 gives the complete RBSOA characteristics.

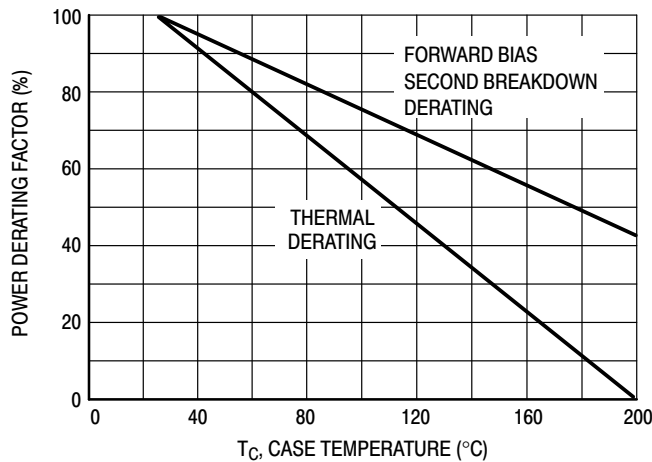
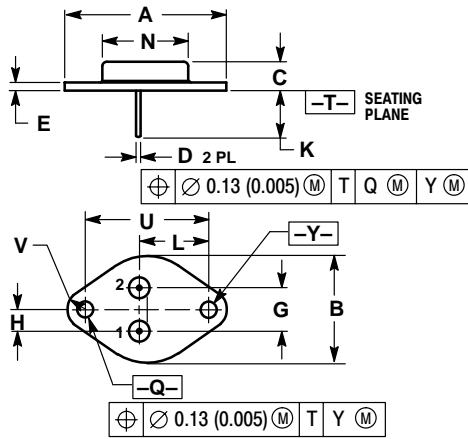

Figure 14. Power Derating

MJ13333

PACKAGE DIMENSIONS

CASE 1-07 TO-204AA (TO-3) ISSUE Z



- NOTES:
1. DIMENSIONING AND TOLERANCING PER ANSI Y14.5M, 1982.
 2. CONTROLLING DIMENSION: INCH.
 3. ALL RULES AND NOTES ASSOCIATED WITH REFERENCED TO-204AA OUTLINE SHALL APPLY.

DIM	INCHES		MILLIMETERS	
	MIN	MAX	MIN	MAX
A	1.550 REF		39.37 REF	
B	---	1.050	---	26.67
C	0.250	0.335	6.35	8.51
D	0.038	0.043	0.97	1.09
E	0.055	0.070	1.40	1.77
G	0.430 BSC		10.92 BSC	
H	0.215 BSC		5.46 BSC	
K	0.440	0.480	11.18	12.19
L	0.665 BSC		16.89 BSC	
N	---	0.830	---	21.08
Q	0.151	0.165	3.84	4.19
U	1.187 BSC		30.15 BSC	
V	0.131	0.188	3.33	4.77

STYLE 1:
PIN 1: BASE
2: EMITTER
CASE: COLLECTOR

SWITCHMODE is a trademark of Semiconductor Components Industries, LLC.

ON Semiconductor and  are trademarks of Semiconductor Components Industries, LLC (SCILLC). SCILLC reserves the right to make changes without further notice to any products herein. SCILLC makes no warranty, representation or guarantee regarding the suitability of its products for any particular purpose, nor does SCILLC assume any liability arising out of the application or use of any product or circuit, and specifically disclaims any and all liability, including without limitation special, consequential or incidental damages. "Typical" parameters which may be provided in SCILLC data sheets and/or specifications can and do vary in different applications and actual performance may vary over time. All operating parameters, including "Typicals" must be validated for each customer application by customer's technical experts. SCILLC does not convey any license under its patent rights nor the rights of others. SCILLC products are not designed, intended, or authorized for use as components in systems intended for surgical implant into the body, or other applications intended to support or sustain life, or for any other application in which the failure of the SCILLC product could create a situation where personal injury or death may occur. Should Buyer purchase or use SCILLC products for any such unintended or unauthorized application, Buyer shall indemnify and hold SCILLC and its officers, employees, subsidiaries, affiliates, and distributors harmless against all claims, costs, damages, and expenses, and reasonable attorney fees arising out of, directly or indirectly, any claim of personal injury or death associated with such unintended or unauthorized use, even if such claim alleges that SCILLC was negligent regarding the design or manufacture of the part. SCILLC is an Equal Opportunity/Affirmative Action Employer.

PUBLICATION ORDERING INFORMATION

NORTH AMERICA Literature Fulfillment:

Literature Distribution Center for ON Semiconductor
P.O. Box 5163, Denver, Colorado 80217 USA
Phone: 303-675-2175 or 800-344-3860 Toll Free USA/Canada
Fax: 303-675-2176 or 800-344-3867 Toll Free USA/Canada
Email: ONlit@hibbertco.com
Fax Response Line: 303-675-2167 or 800-344-3810 Toll Free USA/Canada

N. American Technical Support: 800-282-9855 Toll Free USA/Canada

EUROPE: LDC for ON Semiconductor – European Support

German Phone: (+1) 303-308-7140 (Mon-Fri 2:30pm to 7:00pm CET)
Email: ONlit-german@hibbertco.com
French Phone: (+1) 303-308-7141 (Mon-Fri 2:00pm to 7:00pm CET)
Email: ONlit-french@hibbertco.com
English Phone: (+1) 303-308-7142 (Mon-Fri 12:00pm to 5:00pm GMT)
Email: ONlit@hibbertco.com

EUROPEAN TOLL-FREE ACCESS*: 00-800-4422-3781
*Available from Germany, France, Italy, UK, Ireland

CENTRAL/SOUTH AMERICA:

Spanish Phone: 303-308-7143 (Mon-Fri 8:00am to 5:00pm MST)
Email: ONlit-spanish@hibbertco.com
Toll-Free from Mexico: Dial 01-800-288-2872 for Access –
then Dial 866-297-9322

ASIA/PACIFIC: LDC for ON Semiconductor – Asia Support
Phone: 1-303-675-2121 (Tue-Fri 9:00am to 1:00pm, Hong Kong Time)

Toll Free from Hong Kong & Singapore:
001-800-4422-3781

Email: ONlit-asia@hibbertco.com

JAPAN: ON Semiconductor, Japan Customer Focus Center
4-32-1 Nishi-Gotanda, Shinagawa-ku, Tokyo, Japan 141-0031
Phone: 81-3-5740-2700
Email: r14525@onsemi.com

ON Semiconductor Website: <http://onsemi.com>

For additional information, please contact your local Sales Representative.