

High Efficiency, Low Quiescent, Triple Output DC-DC Converter

General Description

The RT9267 is a triple output DC-DC converter IC including two adaptive PWM controllers, one low dropout regulator, and one voltage detector. RT9267 is capable of delivering hundreds of mA output current and consumes only 40µA quiescent current for the whole IC.

The adaptive PWM controllers are configured for boost applications with built-in 2ANMOS for each channel. The proprietary adaptive PWM loop provides PWM operation for heavier output loading conditions and PFM for lighter loading, with seamless auto-transition. The 550kHz switching rate reduces the size of external passive components.

The low dropout linear regulator (LDO) is designed with a built-in 300mA PMOS, providing 1mV/mA low dropout voltage with respect to variant output current values.

The voltage detector provides the supervisory function with open collector pull-low output. All the 4 function units are adjustable, and each can be set with two resistors in divider connection. The reference voltage for each channel is set to 1.25V for the two adaptive PWM controllers, and 0.86V for the LDO and the voltage detector.

The RT9267 is in TSSOP 16 pin package which fits space-limited hand held devices well.

Ordering Information

RT9267□ □

- Package Type
C : TSSOP-16
- Operating Temperature Range
P : Pb Free with Commercial Standard
G : Green (Halogen Free with Commercial Standard)

Note :

RichTek Pb-free and Green products are :

- ▶RoHS compliant and compatible with the current requirements of IPC/JEDEC J-STD-020.
- ▶Suitable for use in SnPb or Pb-free soldering processes.
- ▶100%matte tin (Sn) plating.

Features

- Two Channels of Adaptive PWM Controllers
- One Channel of Low Dropout Regulator
- One Voltage Detector
- Low Start-Up Voltage 1.0V
- Low Quiescent Current 40µA for the Whole IC
- High Switching Rate 550kHz
- Built-In 2A Switching NMOS
- Two Separated Chip Enable Control Pins
- 2% Accuracy for All Channels
- Minimized External Components
- Small TSSOP-16 Package
- RoHS Compliant and 100% Lead (Pb)-Free

Applications

- PDA
- Portable Instrument
- Wireless Equipment
- DSC
- LCD Back Bias Circuit
- RF-Tags

Pin Configurations

(TOP VIEW)

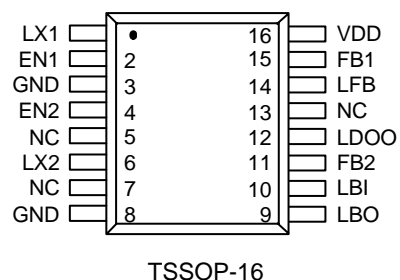

Typical Application Circuit

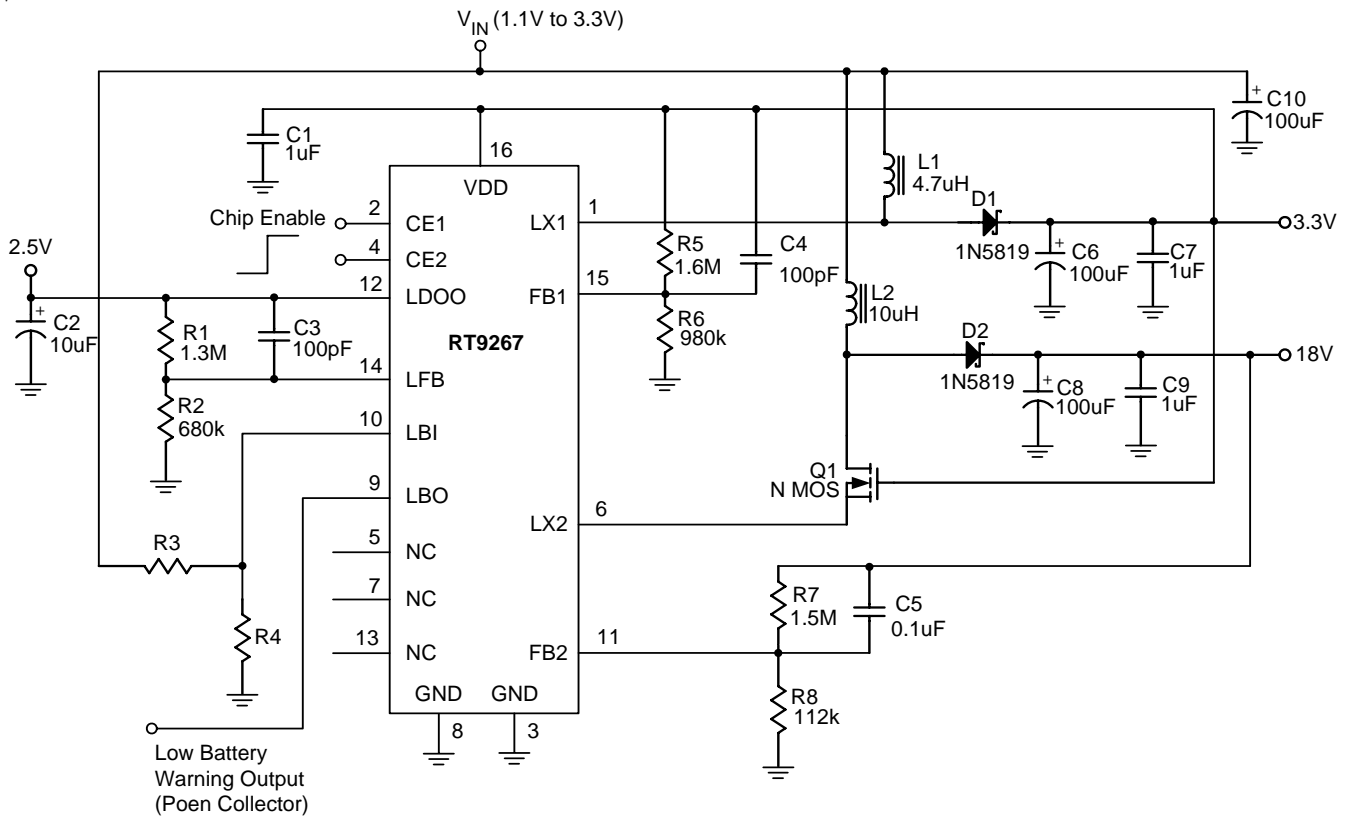

Functional Pin Description

Pin No.	Pin Name	Pin Function
1	LX1	The Switching Pin for 1 st PWM Converter
2	EN1	Enable Pin for 1 st PWM Converter and LDO. (Active High)
3	GND	Ground (Both Pin3 and Pin8 should be connected)
4	EN2	Enable Pin for 2 nd PWM Converter and Voltage Detector. (Active High)
5	NC	Not Connected
6	LX2	The Switching Pin for 2 nd PWM Converter
7	NC	Not Connected
8	GND	Ground (Both Pin3 and Pin8 should be connected)
9	LBO	NMOS Open Drain Output of the Voltage Detector. This pin will internally pulled low when the voltage at LBI pin below 0.86V.
10	LBI	Input Pin for Voltage Detector. The trip point is 0.86V.
11	FB2	Feedback Input Pin for 2 nd PWM Converter. Internal V _{REF} for the error amplifier is 1.25V.
12	LDOO	Voltage Output Pin for the LDO.
13	NC	Not Connected
14	LFB	Feedback Pin for the LDO. Internal V _{REF} for the error amplifier is 0.86V
15	FB1	Feedback Input Pin for 1 st PWM Converter. Internal V _{REF} for the error amplifier is 1.25V
16	VDD	Input Positive Power Pin of RT9267, and also the Voltage Input Pin for LDO.

Function Block Diagram

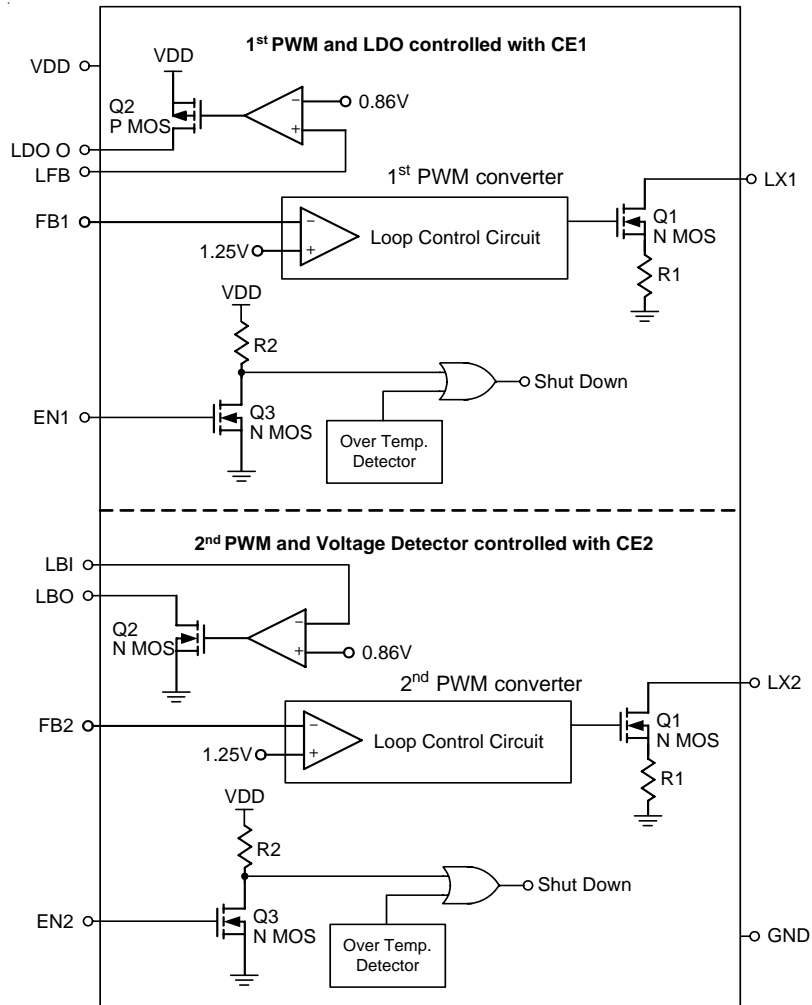

Absolute Maximum Ratings

- Supply Voltage ----- -0.3V to 7V
- LX Pin Switch Voltage ----- -0.3V to (V_{DD} + 0.8V)
- LDO Output Voltage ----- -0.3V to (V_{DD} + 0.3V)
- Other I/O Pin Voltages ----- -0.3V to (V_{DD} + 0.3V)
- LX Pin Switch Current ----- 2.5A
- EXT Pin Driver Current ----- 30mA
- LBO Current ----- 30mA
- Power Dissipation, P_D @ T_A = 25°C
 - TSSOP-16 ----- 600mW
- Operating Junction Temperature ----- 150°C
- Storage Temperature Range ----- -65°C to +150°C

Electrical Characteristics

($V_{IN} = 5V$, $C_{IN} = C_{OUT} = 1\mu F$, $T_A = 25^\circ C$, unless otherwise specified)

Parameter	Symbol	Test Conditions	Min	Typ	Max	Units
Section for Adaptive PWM Converters						
Start-Up Voltage	V_{ST}	$I_L = 1mA$	--	0.98	1.05	V
Operating VDD Range	V_{DD}	Start-up to $I_{DD} > 250\mu A$	0.8	--	6.5 [*]	V
Feedback Reference Voltage	V_{REF}	Close Loop, $V_{DD} = 3.3V$	1.225	1.25	1.275	V
Switching Rate	F_S	$V_{DD} = 3.3V$	--	550	--	kHz
Maximum Duty	D_{MAX}	$V_{DD} = 3.3V$	--	92	--	%
LX ON Resistance		$V_{DD} = 3.3V$	--	0.25	--	Ω
Current Limit Setting	I_{LIMIT}	$V_{DD} = 3.3V$	--	2	--	A
No Load Current (V_{IN})	$I_{NO\ LOAD}$	$V_{IN} = 1.5V$, $V_{OUT} = 3.3V$	--	47	--	μA
Switch-off Current (VDD)	$I_{SWITCH\ OFF}$	$V_{IN} = 6V$	--	17	--	μA
Line Regulation	ΔV_{LINE}	$V_{IN} = 1.5 \sim 2.5V$, $I_L = 1mA$	--	10	--	mV/V
Load Regulation	ΔV_{LOAD}	$V_{IN} = 2.5V$, $I_L = 1 \sim 100mA$	--	0.25	--	mV/mA
Section for LDO						
LDO PMOS ON Resistance		$V_{DD} = 3.3V$	--	1	1.5	Ω
LDO Drop Out Voltage	V_{DROP}	$V_{DD} = 3.3V$, $I_L = 100mA$	--	100	--	mV
Feedback Reference Voltage for LDO	V_{REF}	Close Loop, $V_{DD} = 3.3V$	0.843	0.86	0.877	V
Section for Voltage Detector						
LBO ON Resistance		$V_{DD} = 3.3V$	--	40	--	Ω
LBI Pin Trip Point		$V_{DD} = 3.3V$	0.843	0.86	0.877	V
Section for Whole Chip Property						
Operating VDD Range	V_{DD}	Start-up to $I_{DD1} > 250\mu A$	0.8	--	6	V
Shutdown Current (V_{IN})	I_{OFF}	$EN1 = EN2 = 0$, $V_{IN} = 4.5V$	--	0.1	1	μA
EN Pin Trip Level		$V_{DD} = 3.3V$	0.4	1.0	1.4	V
Temperature Stability for FB, LFB, LBI	T_S	Guaranteed by Design	--	40	--	ppm/ $^\circ C$
Thermal Shutdown	T_{SD}		--	165	--	$^\circ C$

* **Note.** The EN pin shall be tied to VDD pin and inhibit to act the ON/OFF state whenever the VDD pin voltage may reach to 5.5V or above, in case that VDD pin is conducted from VIN.

Typical Operating Characteristics

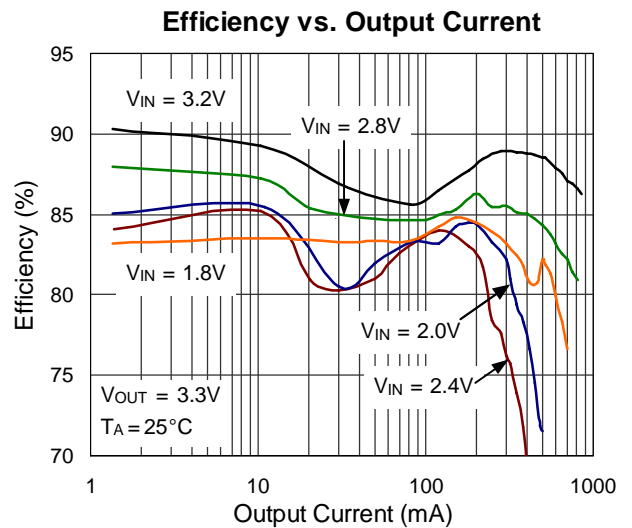
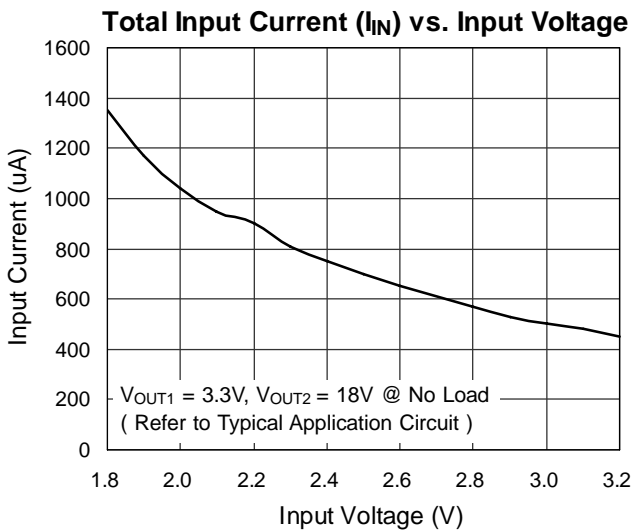
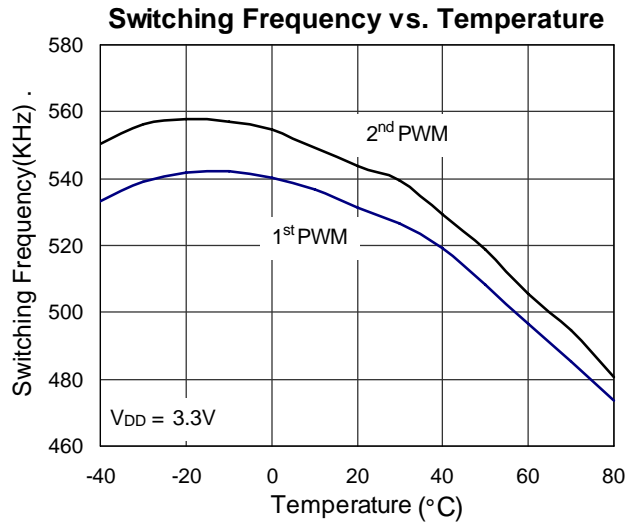
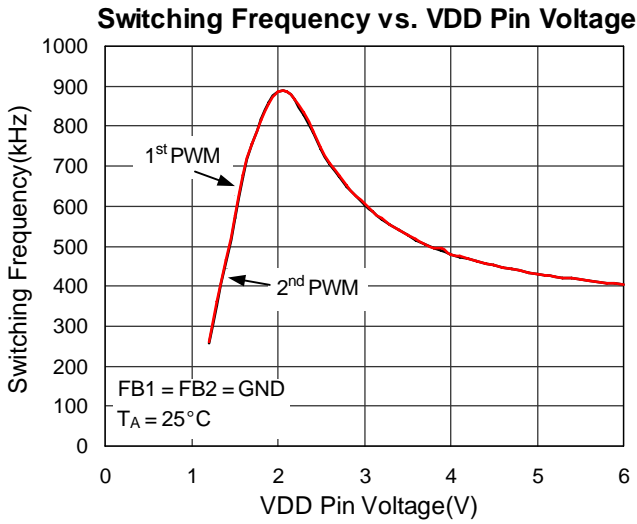
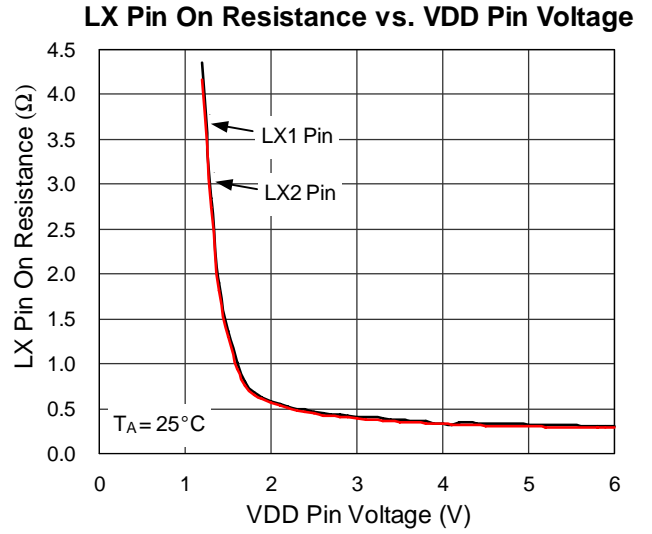
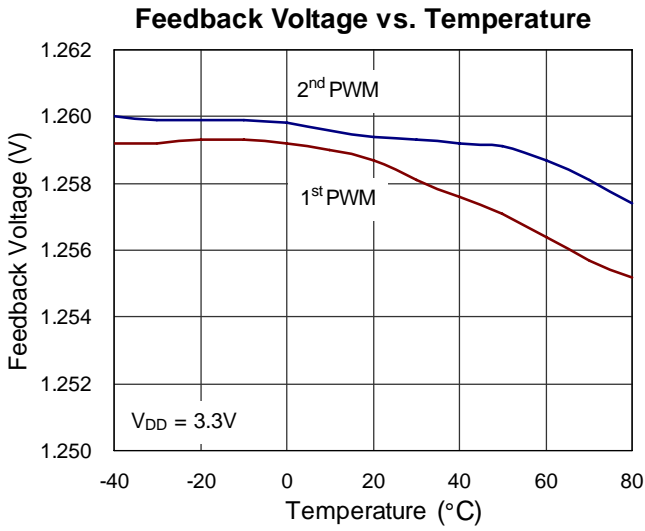

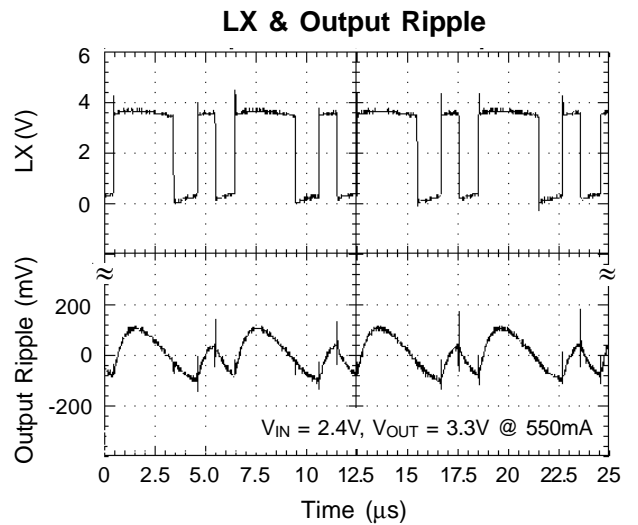
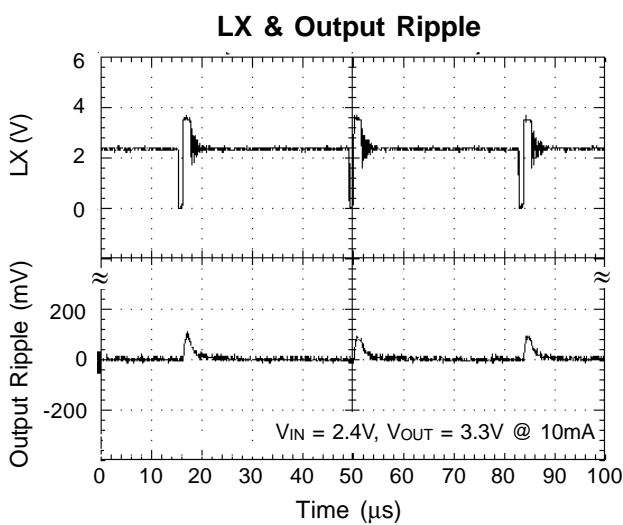
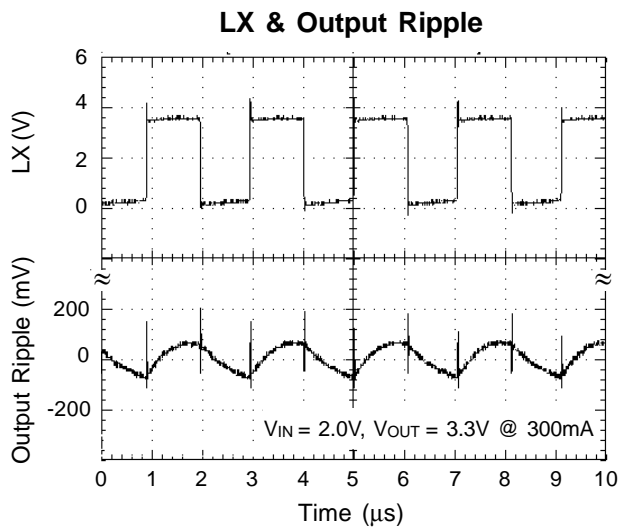
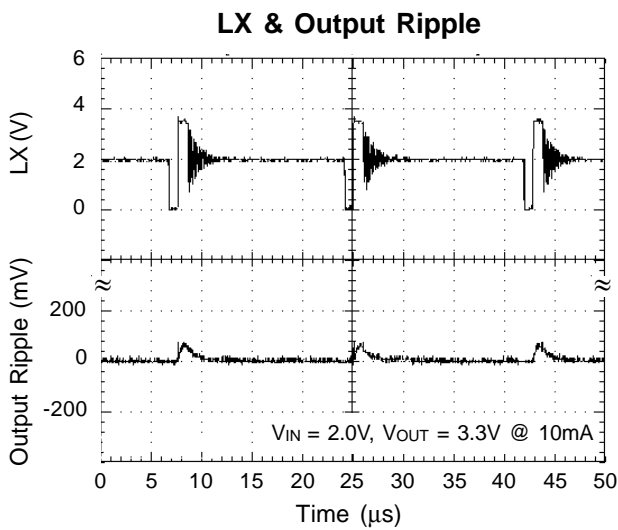
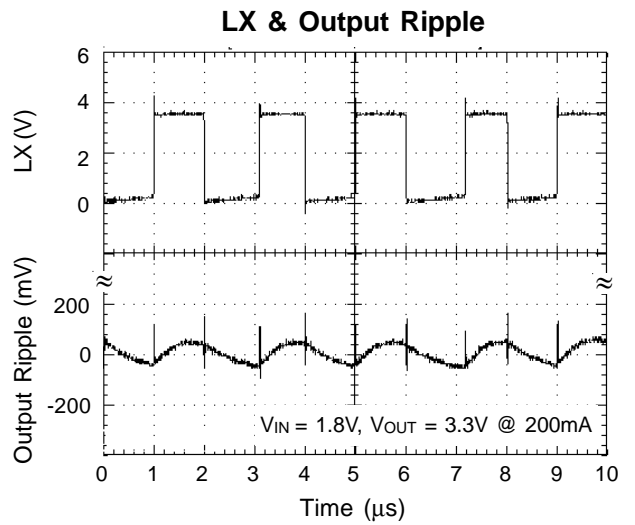
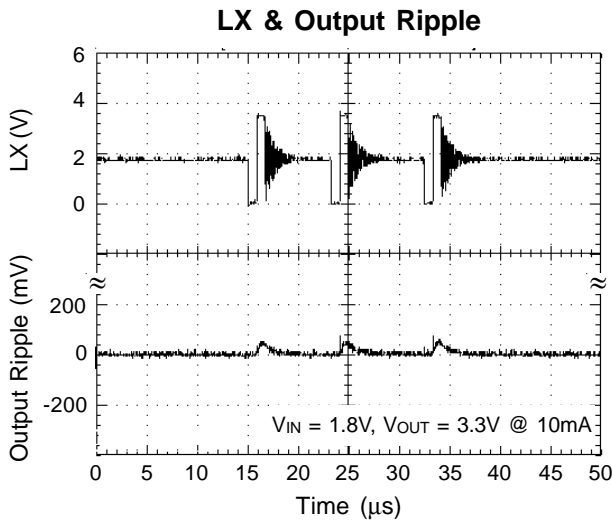

LX & Output Ripple

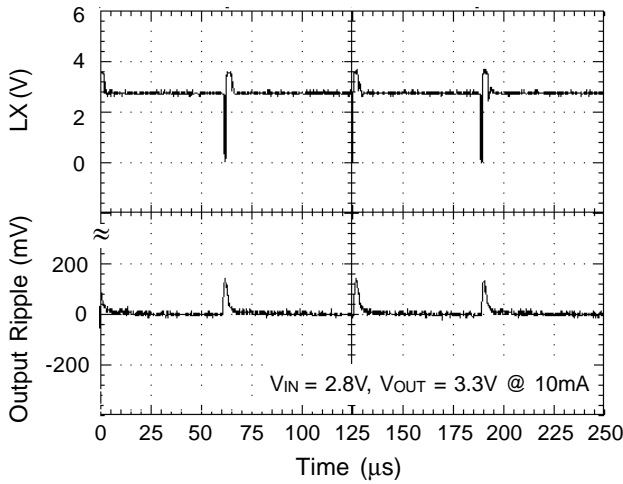

LX & Output Ripple

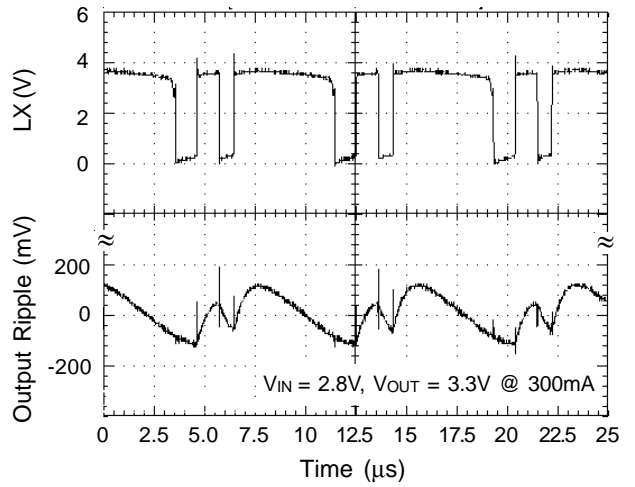

LX & Output Ripple

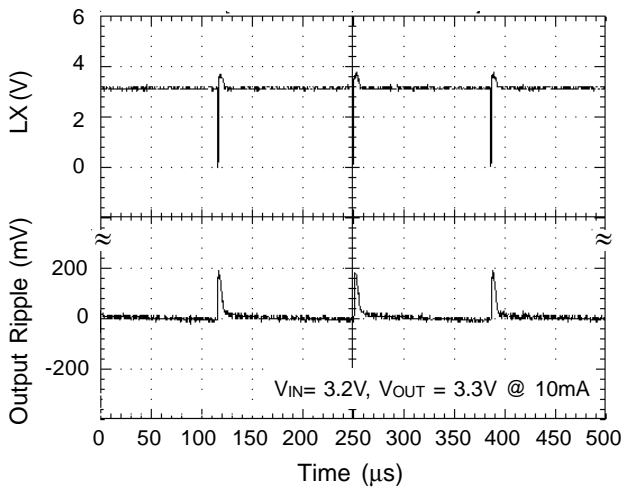

LX & Output Ripple

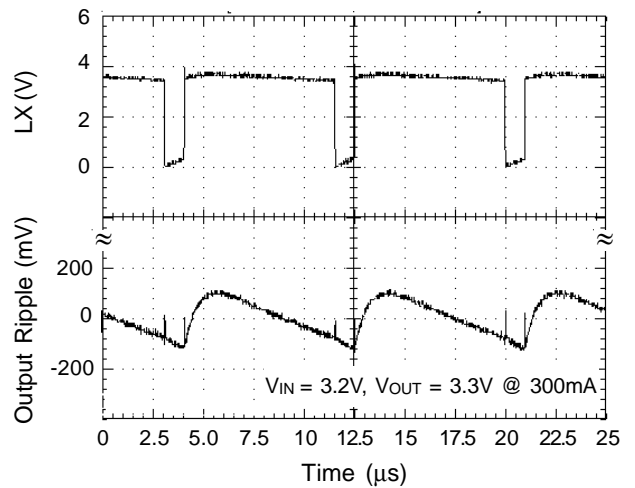

Transient Response

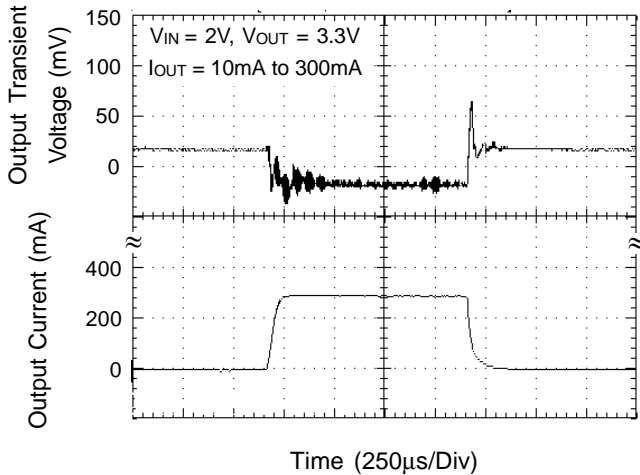

Transient Response

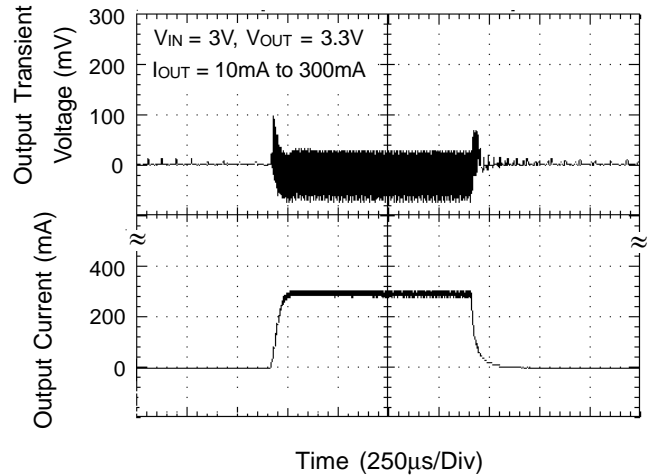

LDO Transient Response

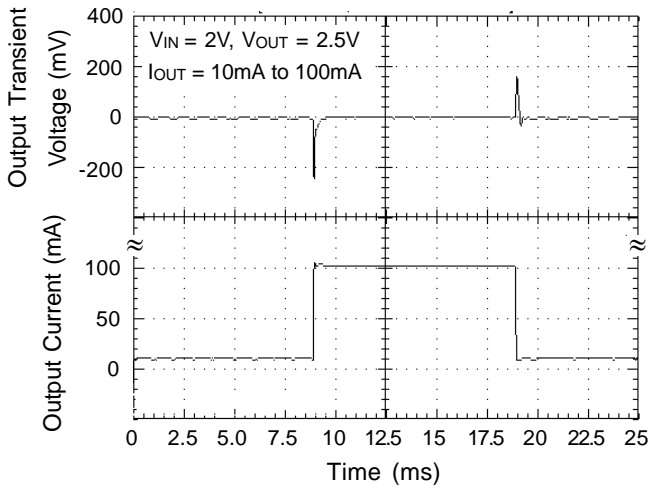

LDO Transient Response

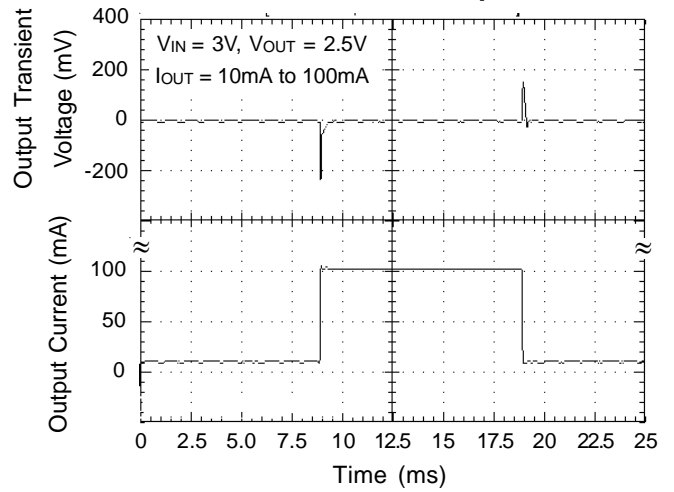

LDO Dropout Voltage vs. Output Current

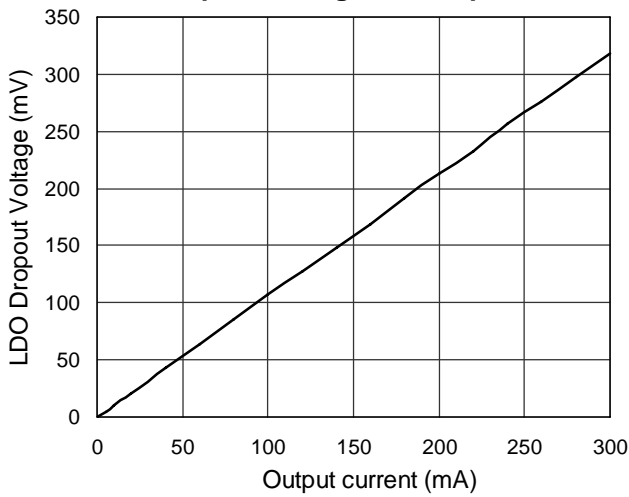

Outline Dimension

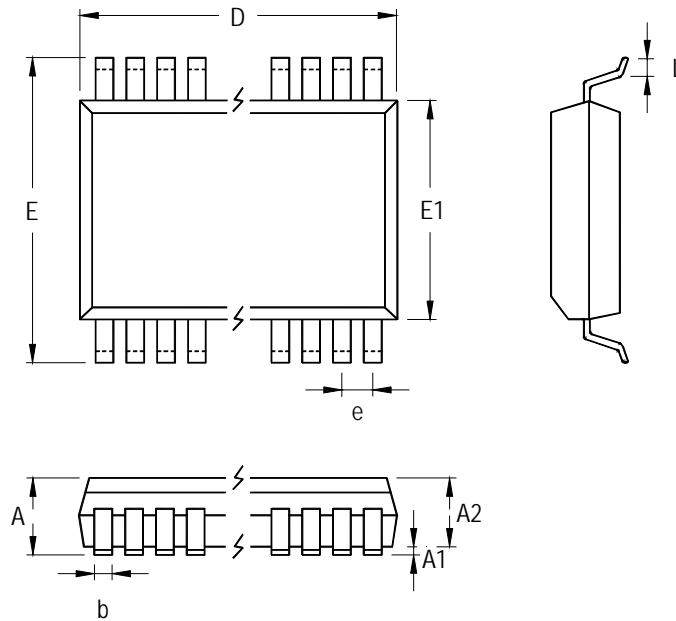

Symbol	Dimensions In Millimeters		Dimensions In Inches	
	Min	Max	Min	Max
A	1.000	1.200	0.039	0.047
A1	0.050	0.150	0.002	0.006
A2	0.800	1.050	0.031	0.041
b	0.190	0.300	0.007	0.012
D	4.900	5.100	0.193	0.201
e	0.650		0.026	
E	6.200	6.600	0.244	0.260
E1	4.300	4.500	0.169	0.177
L	0.450	0.750	0.018	0.030

16-Lead TSSOP Plastic Package

Richtek Technology Corporation

Headquarter
 5F, No. 20, Taiyuen Street, Chupei City
 Hsinchu, Taiwan, R.O.C.
 Tel: (8863)5526789 Fax: (8863)5526611

Richtek Technology Corporation

Taipei Office (Marketing)
 8F, No. 137, Lane 235, Paochiao Road, Hsintien City
 Taipei County, Taiwan, R.O.C.
 Tel: (8862)89191466 Fax: (8862)89191465
 Email: marketing@richtek.com