

- 40 W at 25°C Case Temperature
- 1 A Continuous Collector Current
- 2 A Peak Collector Current
- 20 mJ Reverse-Energy Rating

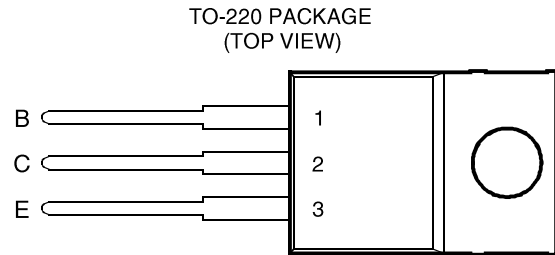

Pin 2 is in electrical contact with the mounting base.

absolute maximum ratings **at 25°C case temperature (unless otherwise noted)**

RATING		SYMBOL	VALUE	UNIT
Collector-base voltage ($I_E = 0$)	TIP47	V_{CBO}	350	V
	TIP48		400	
	TIP49		450	
	TIP50		500	
Collector-emitter voltage ($I_B = 0$)	TIP47	V_{CEO}	250	V
	TIP48		300	
	TIP49		350	
	TIP50		400	
Emitter-base voltage		V_{EBO}	5	V
Continuous collector current		I_C	1	A
Peak collector current (see Note 1)		I_{CM}	2	A
Continuous base current		I_B	0.6	A
Continuous device dissipation at (or below) 25°C case temperature (see Note 2)		P_{tot}	40	W
Continuous device dissipation at (or below) 25°C free air temperature (see Note 3)		P_{tot}	2	W
Unclamped inductive load energy (see Note 4)		$\frac{1}{2}LI_C^2$	20	mJ
Operating junction temperature range		T_j	-65 to +150	°C
Storage temperature range		T_{stg}	-65 to +150	°C
Lead temperature 3.2 mm from case for 10 seconds		T_L	260	°C

- NOTE 1: This value applies for $t_p \leq 1$ ms, duty cycle $\leq 2\%$.
- 2: Derate linearly to 150°C case temperature at the rate of 0.32 W/°C.
- 3: Derate linearly to 150°C free air temperature at the rate of 16 mW/°C.
- 4: This rating is based on the capability of the transistor to operate safely in a circuit of: $L = 20$ mH, $I_{B(on)} = 0.4$ A, $R_{BE} = 100 \Omega$, $V_{BE(off)} = 0$, $R_S = 0.1 \Omega$, $V_{CC} = 20$ V.

TIP47, TIP48, TIP49, TIP50 NPN SILICON POWER TRANSISTORS

electrical characteristics at 25°C case temperature

PARAMETER	TEST CONDITIONS			MIN	TYP	MAX	UNIT
$V_{(BR)CEO}$ Collector-emitter breakdown voltage	$I_C = 30 \text{ mA}$ (see Note 5)	$I_B = 0$	TIP47 TIP48 TIP49 TIP50	250 300 350 400			V
I_{CES} Collector-emitter cut-off current	$V_{CE} = 350 \text{ V}$ $V_{CE} = 400 \text{ V}$ $V_{CE} = 450 \text{ V}$ $V_{CE} = 500 \text{ V}$	$V_{BE} = 0$ $V_{BE} = 0$ $V_{BE} = 0$ $V_{BE} = 0$	TIP47 TIP48 TIP49 TIP50			1 1 1 1	mA
I_{CEO} Collector cut-off current	$V_{CE} = 150 \text{ V}$ $V_{CE} = 200 \text{ V}$ $V_{CE} = 250 \text{ V}$ $V_{CE} = 300 \text{ V}$	$I_B = 0$ $I_B = 0$ $I_B = 0$ $I_B = 0$	TIP47 TIP48 TIP49 TIP50			1 1 1 1	mA
I_{EBO} Emitter cut-off current	$V_{EB} = 5 \text{ V}$	$I_C = 0$				1	mA
h_{FE} Forward current transfer ratio	$V_{CE} = 10 \text{ V}$ $V_{CE} = 10 \text{ V}$	$I_C = 0.3 \text{ A}$ $I_C = 1 \text{ A}$	(see Notes 5 and 6)	30 10		150	
$V_{CE(sat)}$ Collector-emitter saturation voltage	$I_B = 0.2 \text{ A}$	$I_C = 1 \text{ A}$	(see Notes 5 and 6)			1	V
V_{BE} Base-emitter voltage	$V_{CE} = 10 \text{ V}$	$I_C = 1 \text{ A}$	(see Notes 5 and 6)			1.5	V
h_{fe} Small signal forward current transfer ratio	$V_{CE} = 10 \text{ V}$	$I_C = 0.2 \text{ A}$	$f = 1 \text{ kHz}$	25			
$ h_{fe} $ Small signal forward current transfer ratio	$V_{CE} = 10 \text{ V}$	$I_C = 0.2 \text{ A}$	$f = 2 \text{ MHz}$	5			

NOTES: 5. These parameters must be measured using pulse techniques, $t_p = 300 \mu\text{s}$, duty cycle $\leq 2\%$.

6. These parameters must be measured using voltage-sensing contacts, separate from the current carrying contacts.

resistive-load-switching characteristics at 25°C case temperature

PARAMETER	TEST CONDITIONS †			MIN	TYP	MAX	UNIT
t_{on} Turn on time	$I_C = 1 \text{ A}$	$I_{B(on)} = 0.1 \text{ A}$	$I_{B(off)} = -0.1 \text{ A}$		0.2		μs
t_{off} Turn off time	$V_{BE(off)} = -5 \text{ V}$	$R_L = 200 \Omega$	(see Figures 1 and 2)		2		μs

† Voltage and current values shown are nominal; exact values vary slightly with transistor parameters.

PARAMETER MEASUREMENT INFORMATION

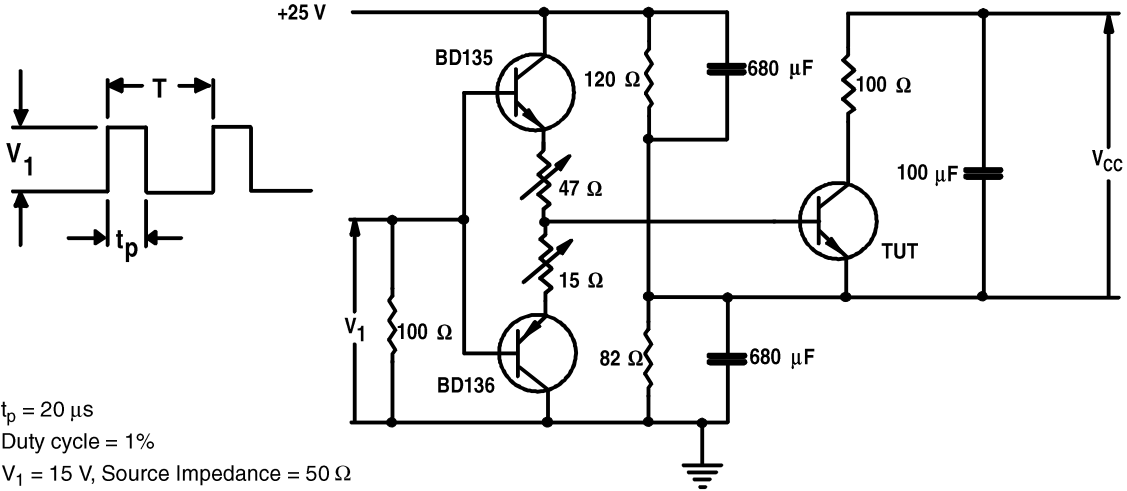

Figure 1. Resistive-Load Switching Test Circuit

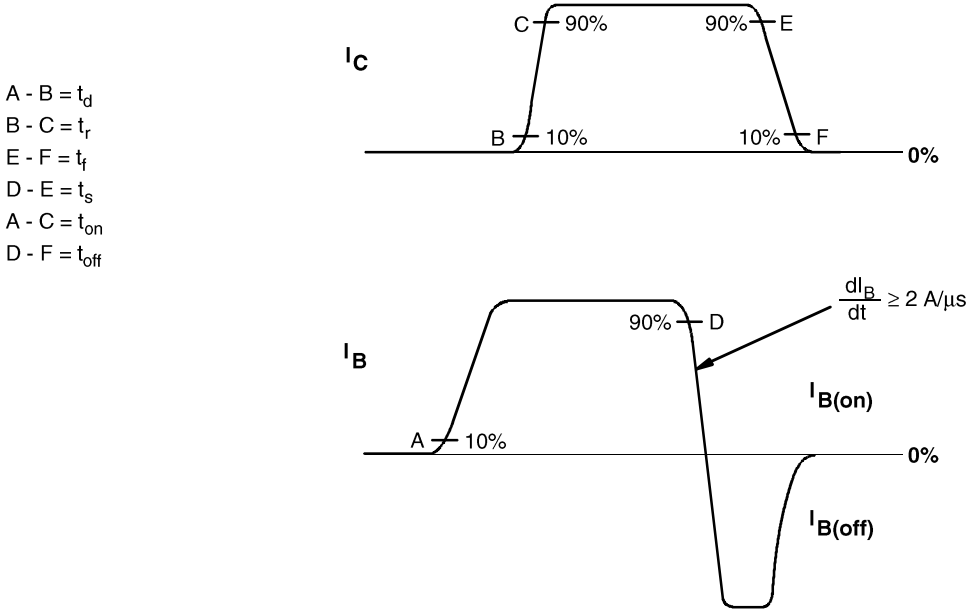

Figure 2. Resistive-Load Switching Waveform

TYPICAL CHARACTERISTICS

TYPICAL DC CURRENT GAIN
 vs
 COLLECTOR CURRENT

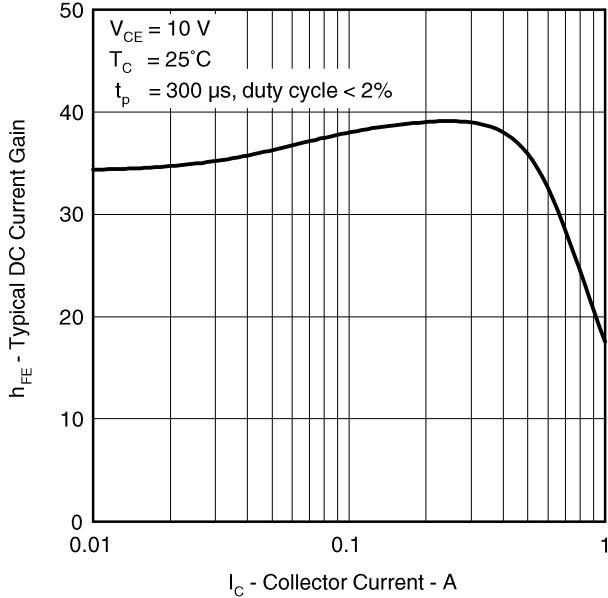

Figure 3.

COLLECTOR-EMITTER SATURATION VOLTAGE
 vs
 COLLECTOR CURRENT

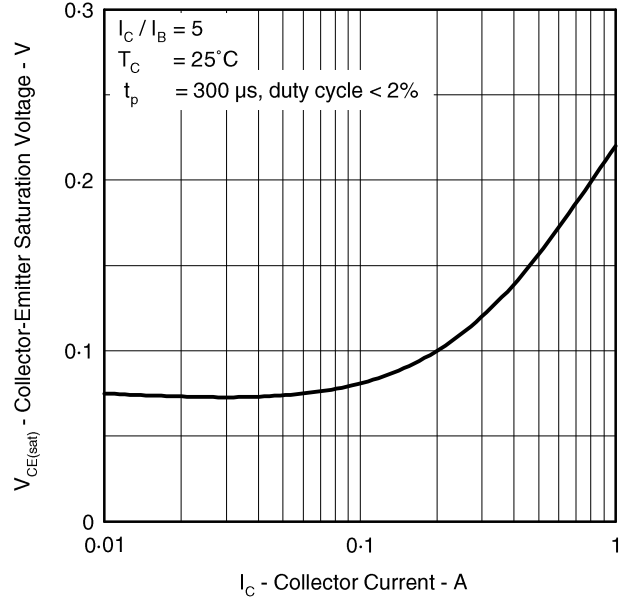

Figure 4.

BASE-EMITTER SATURATION VOLTAGE
 vs
 COLLECTOR CURRENT

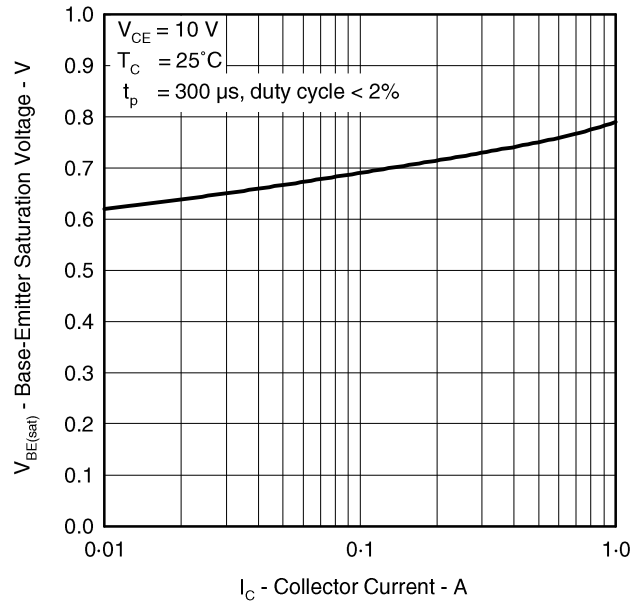

Figure 5.

MAXIMUM SAFE OPERATING REGIONS

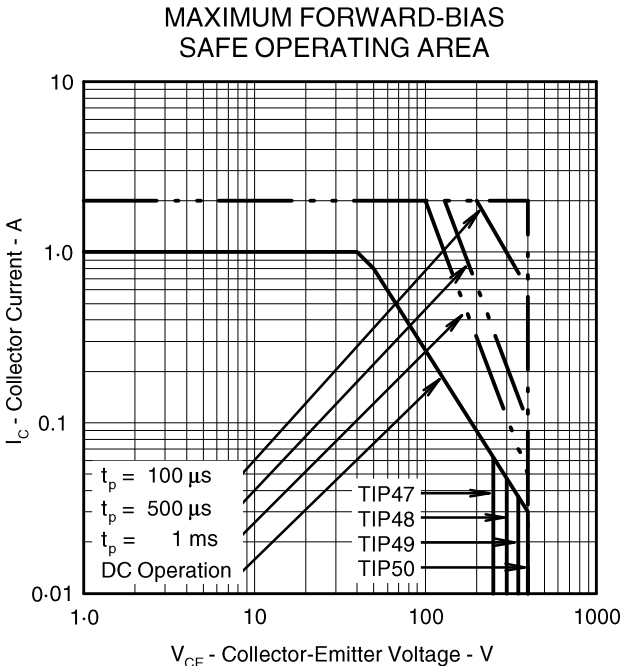

Figure 6.

TIP47, TIP48, TIP49, TIP50
NPN SILICON POWER TRANSISTORS

MECHANICAL DATA

TO-220

3-pin plastic flange-mount package

This single-in-line package consists of a circuit mounted on a lead frame and encapsulated within a plastic compound. The compound will withstand soldering temperature with no deformation, and circuit performance characteristics will remain stable when operated in high humidity conditions. Leads require no additional cleaning or processing when used in soldered assembly.

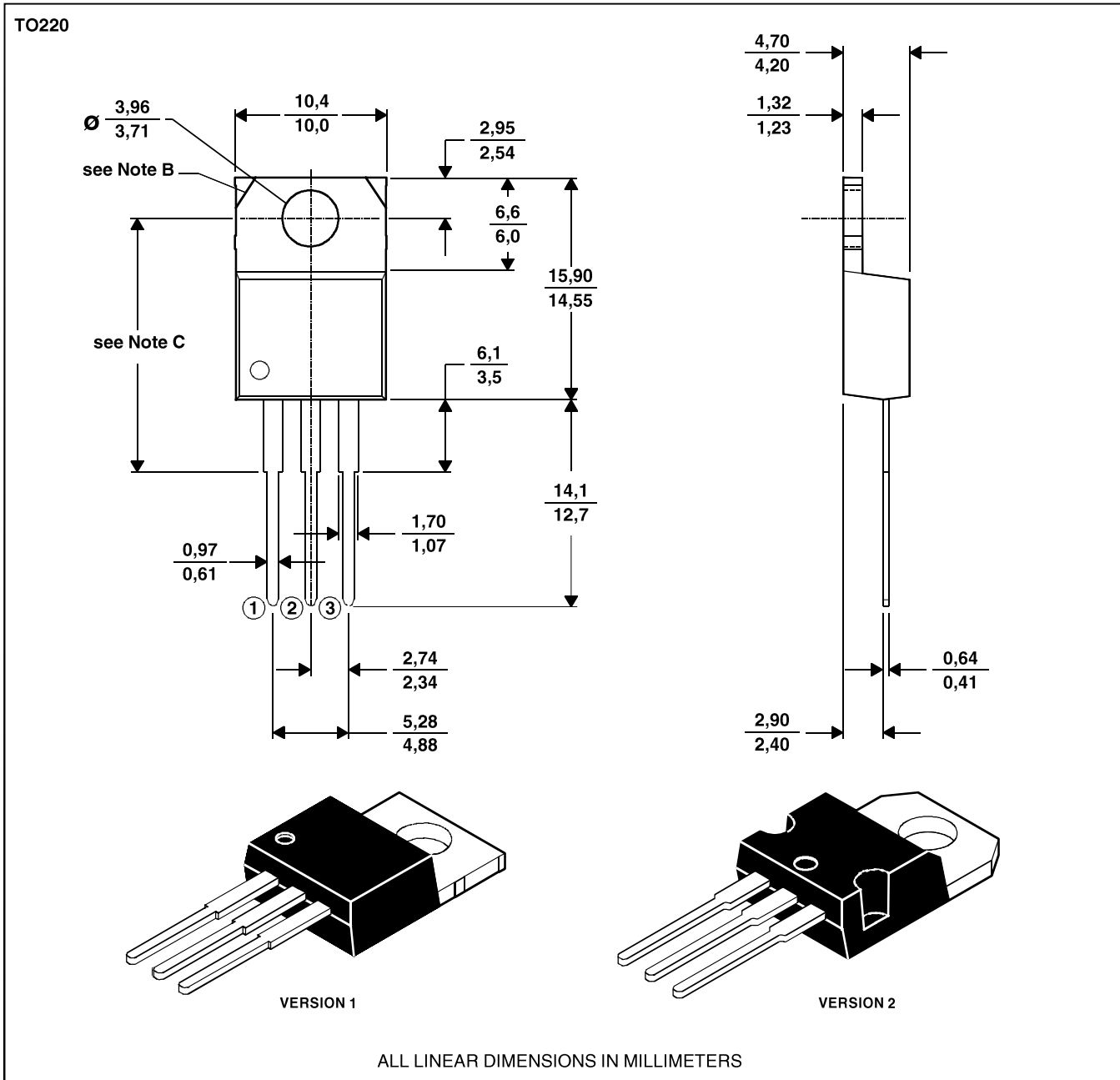

- NOTES: A. The centre pin is in electrical contact with the mounting tab.
 B. Mounting tab corner profile according to package version.
 C. Typical fixing hole centre stand off height according to package version.
 Version 1, 18.0 mm. Version 2, 17.6 mm.